

HIGHSEMI

HIGH Semiconductor

**HIGH POWER BUSINESS
FOR THE INDUSTRIAL MARKET**







Taiwan
Phone:+886-955594581
Office:+886-35886128
E-mail: eddie@uni-e.com

HIGHSEMI

Power Modules

Power Module Products Thyristor / Diode Modules

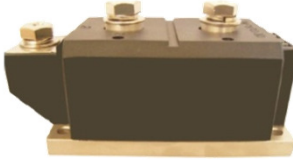
Standard Diodes / Standard Thyristors / Fast Recovery Diodes

AAP 	IAP 	MAP  <small>MAGNA-PAK</small>	MAP-1  <small>MAP Block Power</small>	Super MAP  <small>SUPER MAGN A-PAK</small>	Super MAP-1 
26A to 110A 600V to 1600V	135A to 240A 600V to 1600V	250A to 500A 600V to 1600V	300A to 500A 600V to 2200V	500A to 600A 600V to 2000V	800A to 1000A 600V to 2000V

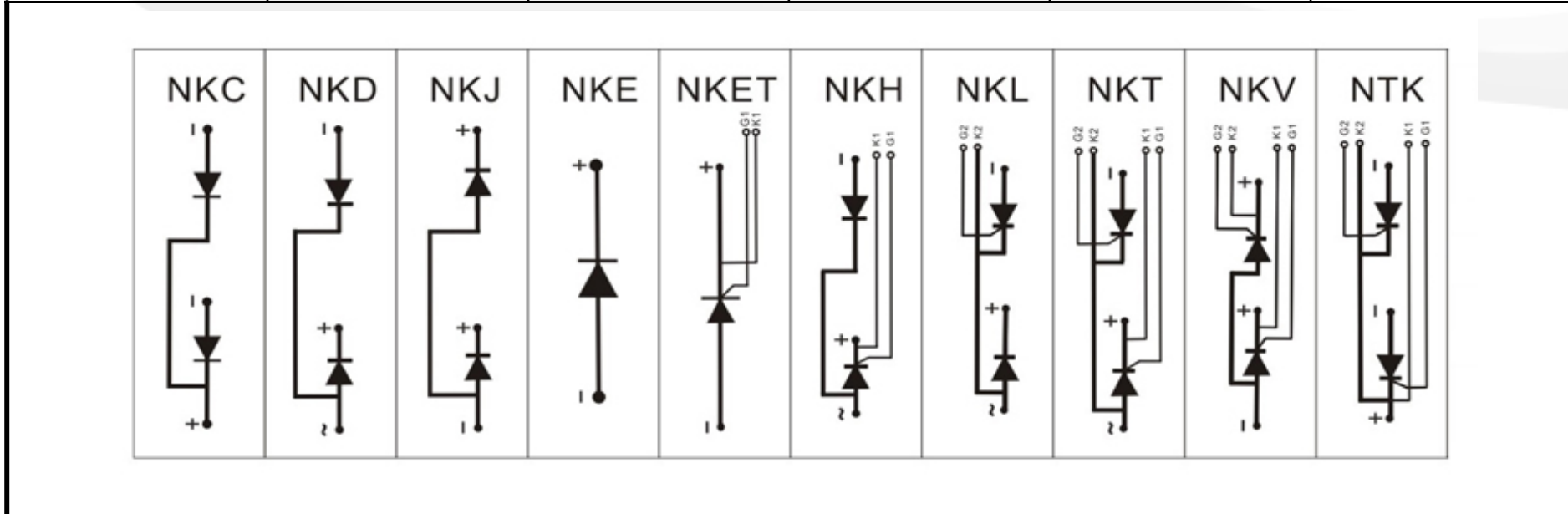

Power Module Products Thyristor / Diode Modules

Three Phase Diodes / Three Phase Thyristors

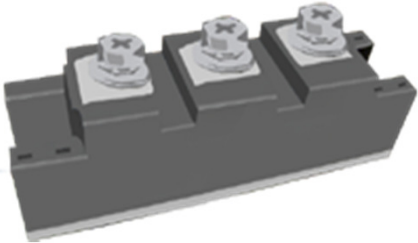
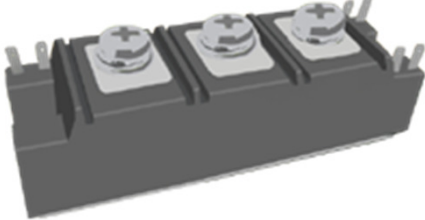
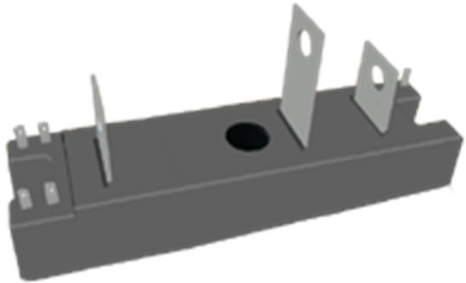
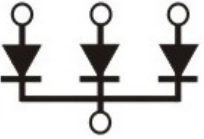
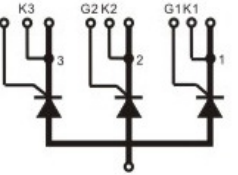
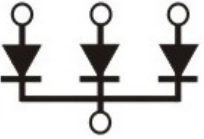
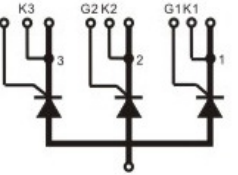
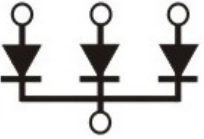
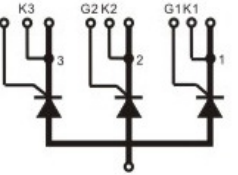
<p>R204</p> 	<p>NK3T</p> 	<p>NK3T-T</p> 		
<p>60A to 130A 400V to 1600V</p>	<p>160A to 200A 400V to 1600V</p>	<p>150A to 200A 400V to 1600V</p>		
<table border="1" style="width: 100%; text-align: center;"> <tr> <td data-bbox="862 986 1120 1406"> <p>NK3D</p>  </td> <td data-bbox="1126 986 1384 1406"> <p>NK3T</p>  </td> </tr> </table>			<p>NK3D</p> 	<p>NK3T</p> 
<p>NK3D</p> 	<p>NK3T</p> 			

Power Module Products

Thyristor / Thyristor Modules

(Low profile type)

NK70KQ~NK135KQ

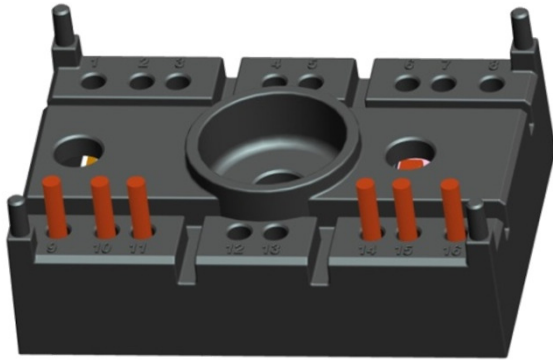

$I_{T(RMS)}$: 70~135A

V_{DRM}/V_{RRM} : 800V to 1600V

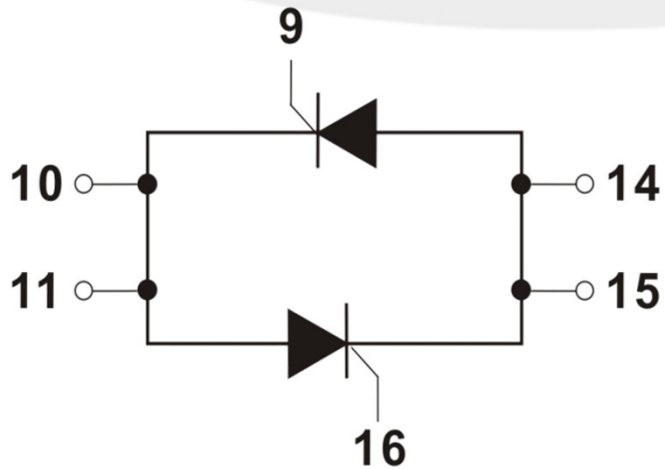

NK60TA~NK120TA

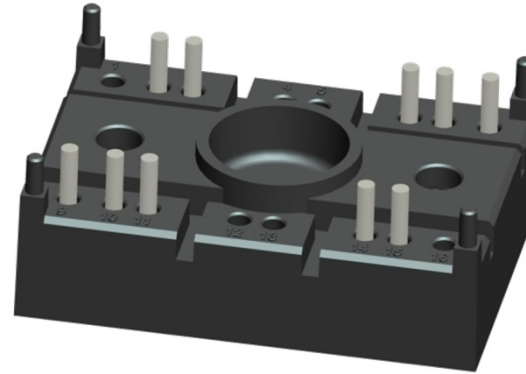



$I_{T(AV)}$: 60~120A

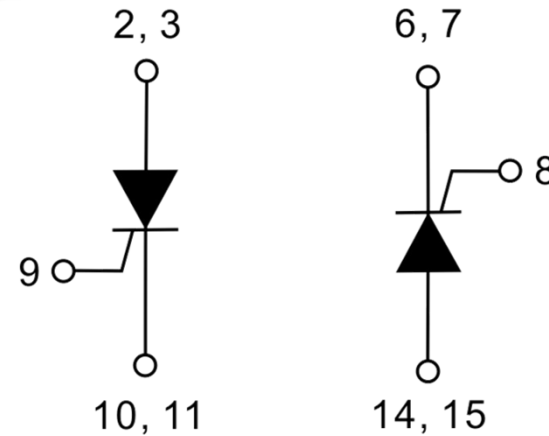

V_{DRM}/V_{RRM} : 800V to 1600V

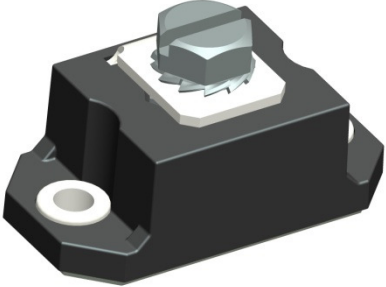
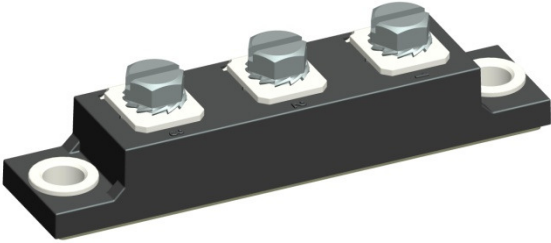
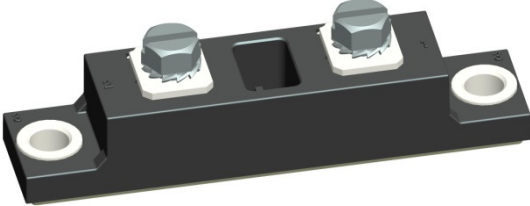

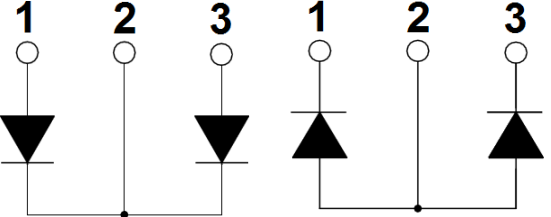
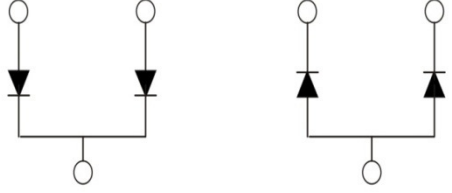
Power Module Products Fast Recovery Diode Modules

Half Pak(non-isolated)	TO-244(insulated)	TO-244(non-insulated)
 <p>110A to 200A 400V to 600V</p>	 <p>100A to 400A 400V to 600V</p>	 <p>100A to 400A 400V to 600V</p>
 <p>Baseplate Baseplate</p>	 <p>Common Cathode Common Anode</p>	<p>Common Cathode Common Anode</p>  <p>Baseplate Baseplate</p>

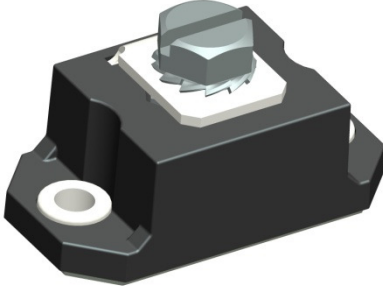
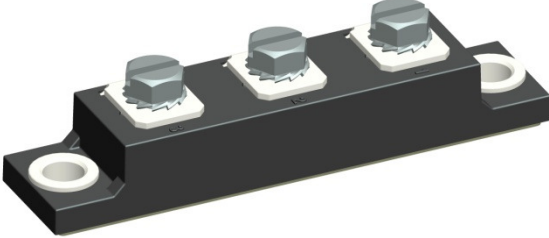
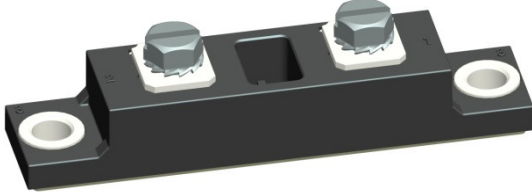
Power Module Products Schottky Barrier Diode Modules

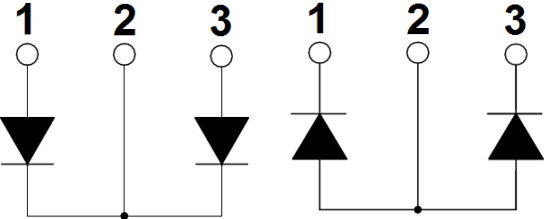
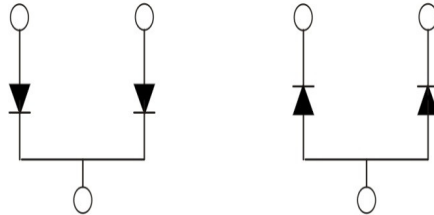
<p>Half Pak(non-insulated)</p> 	<p>TO-244(insulated)</p> 	<p>TO-244(non-insulated)</p> 
<p>110A to 200A 45V to 200V</p>	<p>100A to 400A 45V to 200V</p>	<p>100A to 400A 45V to 200V</p>
 <p>Baseplate Baseplate</p>	 <p>Common Cathode Common Anode</p>	<p>Common Cathode Common Anode</p>  <p>Baseplate Baseplate</p>

Power Module Products

Ultrafast Soft Recovery Diode Rectifier

SOT-227(insulated)

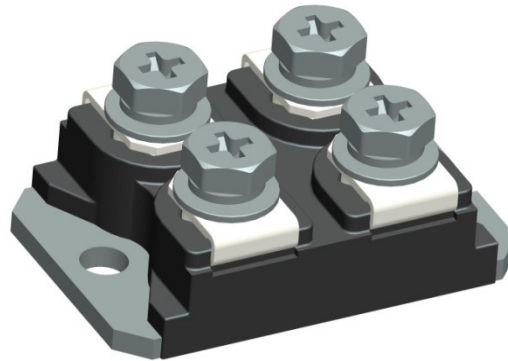

60A 600V
60A 1200V

100A 600V
100A 1200V

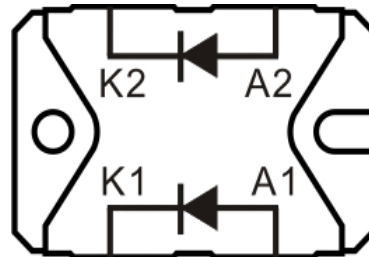

Parallel

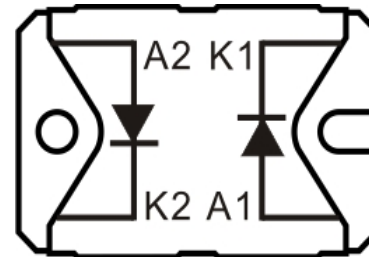

Anti-Parallel

Power Module Products

High Voltage Schottky Diodes

SOT-227(insulated)

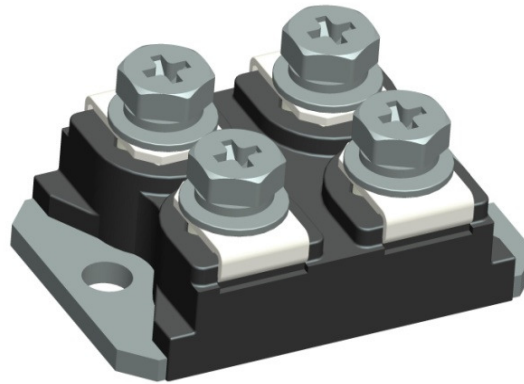

30A / 200V

60A / 200V

100A / 200V

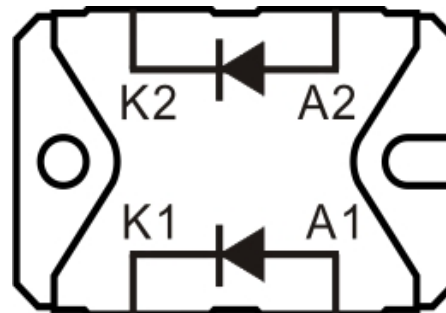

Power Module Products Single Thyristor Module

SOT-227(insulated)

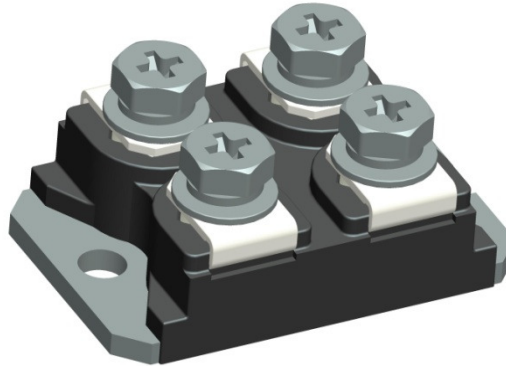



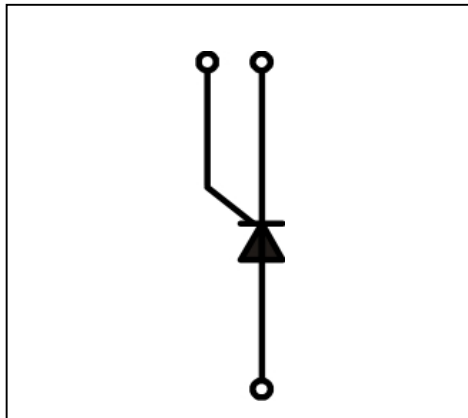

50A to 160A
1200V to 1600V





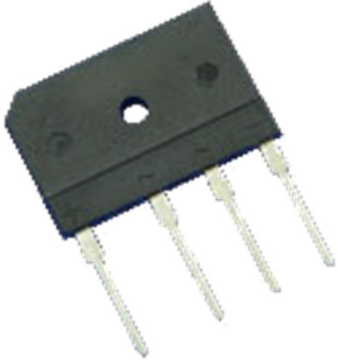
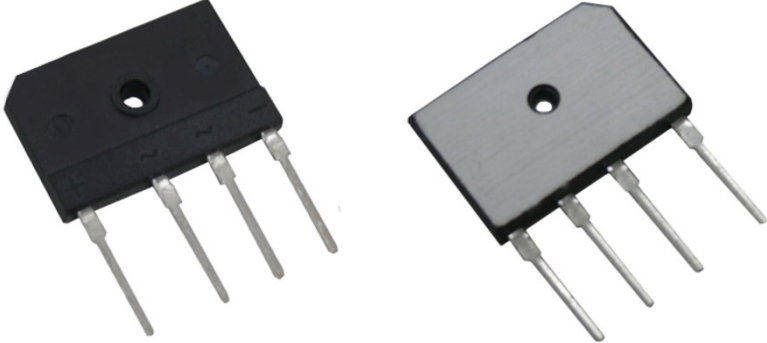

HIGHSEMI

Bridges





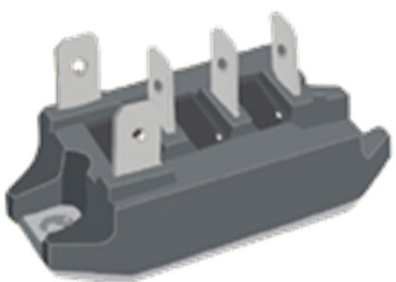
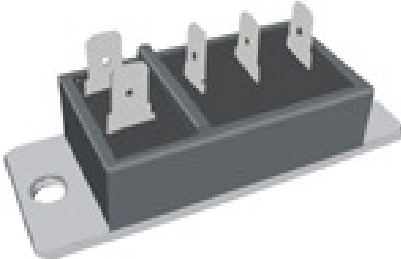
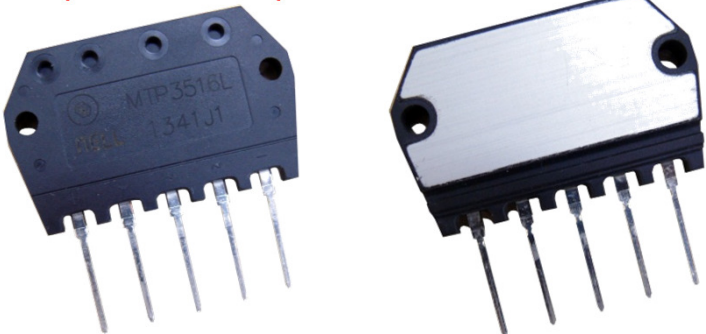

Single Phase Bridge Rectifiers

<p>GBJ</p> 	<p>GBJ-H (with heatsink)</p> 	
<p>10A to 35A 600V to 1200V</p>	<p>25A and 35A 600V to 1200V</p>	
<p>GBPC-M (Molding type)</p> 	<p>KBPC</p> 	<p>GBPC</p> 
<p>15A to 50A 600V to 1200V</p>	<p>15A to 50A 600C to 1200V</p>	<p>15A to 50A 600V to 1200V</p>

Three Phase Bridge Rectifiers(1)

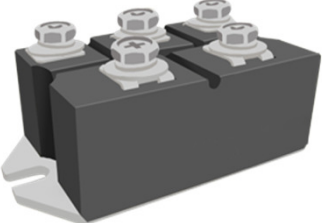
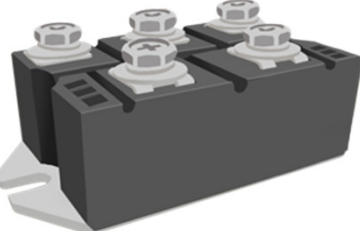
<p>MTP-M1 (Molding type)</p> 	<p>MTP-A1</p> 	<p>MTP-W</p> 	<p>MTP</p> 
<p>35A to 50A 800V to 1600V</p>	<p>25A to 50A 800V to 1600V</p>	<p>35A to 50A 800V to 1600V</p>	<p>30A 800V to 1600V</p>
<p>MTP</p> 	<p>MTP-L (with heatsink)</p> 		<p>MTP-M (molding type)</p> 
<p>30A 800V to 1600V</p>	<p>25A to 50A 800V to 1600V</p>		<p>50A to 150A 800V to 1600V</p>

Three Phase Bridge Rectifiers(2)

<p>MTP</p> 	<p>MTP-S</p> 	<p>MTP-D</p> 	<p>MTP-D</p> 
<p>50A to 100A 800V to 1600V</p>	<p>50A to 100A 800V to 1600V</p>	<p>50A to 100A 800V to 1600V</p>	<p>160A to 250A 800V to 1600V</p>
<p>MTP-I</p> 	<p>MTP</p> 	<p>MTP-S</p> 	
<p>150A to 200A 800V to 1600V</p>	<p>150A to 200A 800V to 1600V</p>	<p>200A to 500A 800V to 1600V</p>	

Bridges 3Ø Bridges + Thyristor

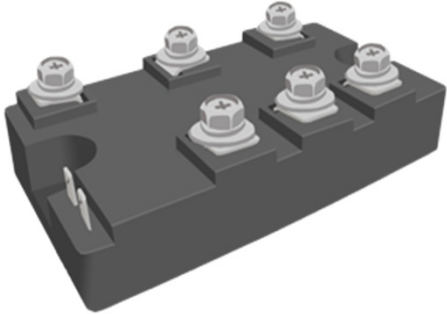
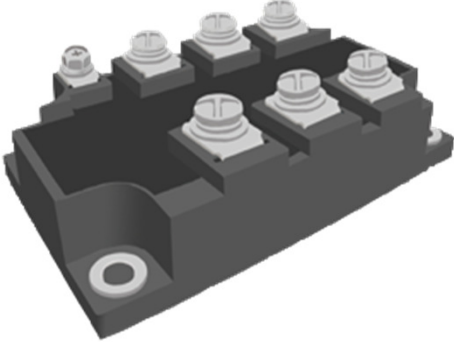
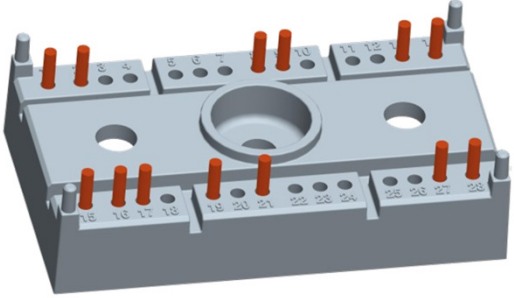
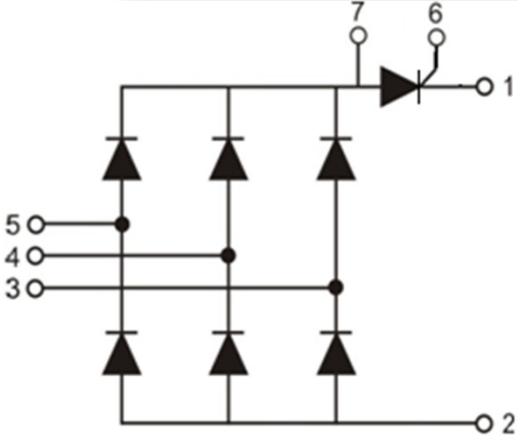
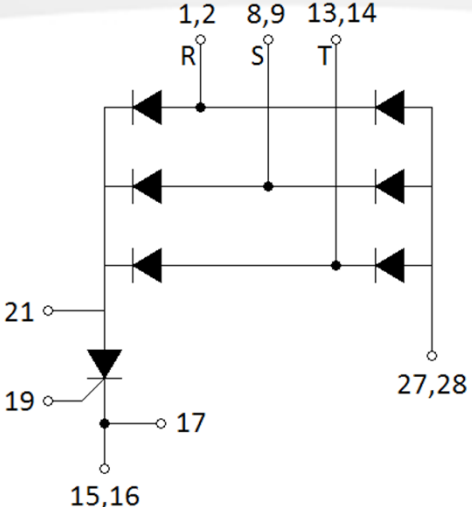
		
<p>50A to 100A 800 to 1600V</p>	<p>150A to 200A 800 to 1600V</p>	<p>60A 800 to 1600V</p>
		

HIGHSEMI

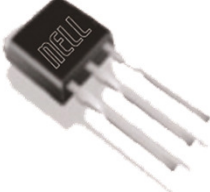
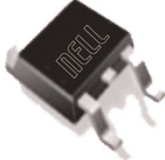
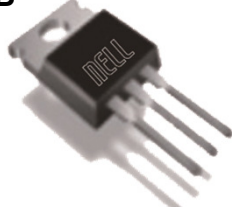

**Plastic Package
and
Discretes**

Plastic Discrete Products SCR Product Family

	TO-92 	TO-251 	TO-252 	TO-220AB 	
600V	1PT06E	4PT06F 6PT06F 8PT06F	4PT06G 6PT06G 8PT06G 10PT06G 12PT06G 16PT06G	4PT06A(I) 6PT06A(I) 8PT06A(I) 10PT06A(I) 12PT06A(I) 16PT06A(I)	20PT06A(I) 25PT06A(I) 30PT06A(I) 40PT06A(I) 55PT06A(I)
800V	1PT08E	4PT08F 6PT08F 8PT08F	4PT08G 6PT08G 8PT08G 10PT08G 12PT06G 16PT08G	4PT08A(I) 6PT08A(I) 8PT08A(I) 10PT08A(I) 12PT08A(I) 16PT08A(I)	20PT08A(I) 25PT08A(I) 30PT08A(I) 40PT08A(I) 55PT08A(I)
1000V to 1600V			8PT10G 10PT10G 12PT10G 16PT10G	8PT10A(I) 10PT10A(I) 12PT10A(I) 16PT10A(I) 20PT10A(I)	25PT12A(I) 25PT16A(I) 30PT12A(I) 30PT16A(I) 40PT12A(I) 40PT16A(I) 55PT12A(I) 55PT16A(I)

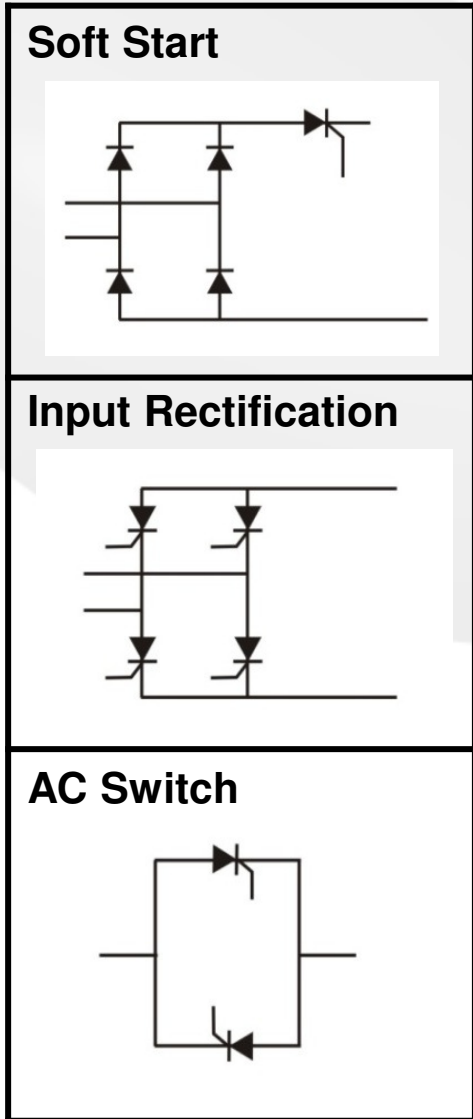
Plastic Discrete Products SCR Product Family

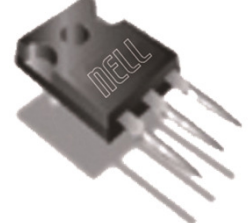



	TO-3P	TO-247	Super-247
800V	 30PT08B(I) 40PT08B(I) 55PT08B(I) 70PT08B(I)	 30PT08C 40PT08C 55PT08C	 70PT08D
1200V	30PT12B(I) 40PT12B(I) 55PT12B(I) 70PT12B(I)	30PT12C 40PT12C 55PT12C 70PT12C	70PT12D
1600V	30PT16B(I) 40PT16B(I) 55PT16B(I) 70PT16B(I)	30PT16C 40PT16C 55PT16C	70PT16D

TRIAC Product Family

	TO-92	TO-251	TO-252	TO-263
				
600V	1T06E	4T06F 6T06F 8T06F	4T06G 6T06G 8T06G	8T06H / 10T06H 12T06H / 16T06H 20T06H / 25T06H
800V	1T08E	4T08F 6T08F 8T08F	4T08G 6T08G 8T08G	8T08H / 10T08H 12T08H / 16T08H 20T08H / 25T08H
1000V to 1200V		8T10F	8T10G	8T10H / 10T10H 12T10H / 16T10H 20T10H / 25T10H 25T12H

“I” for insulated

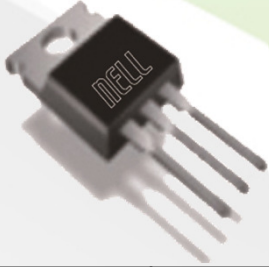
TRIAC Product Family

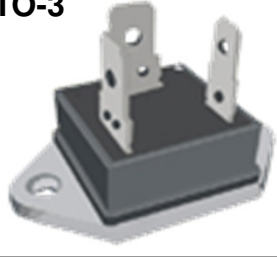



	TO-220AB 	TO-3P 	TO-3 	
600V	4T06A(I) 6T06A(I) 8T06A(I) 10T06A(I)	12T06A(I) 16T06A(I) 20T06A(I) 25T06A(I)	20T06B(I) 25T06B(I) 41T06B(I)	M40T60A M55T60A
800V	4T08A(I) 6T08A(I) 8T08A(I) 10T08A(I)	12T08A(I) 16T08A(I) 20T08A(I) 25T08A(I)	20T08B(I) 25T08B(I) 41T08B(I)	M40T80A M55T80A
1000V to 1200V	4T10A(I) 6T10A(I) 8T10A(I) 10T10A(I)	12T10A(I) 16T10A(I) 20T10A(I) 25T12A(I)	20T10B(I) 25T12B(I) 41T12B(I)	M40T120A M55T120A

HIGHSEMI







Discretes

Discrete Products Standard Recovery Diodes & Fast Recovery Diodes

Stud





DO-4 	DO-5 	DO-30 	DO-9 	B-8 
6A to 25A 200V to 1600V	40A to 85A 200V to 1600V	100A to 200A 200V to 2400V	250A to 400A 200V to 2400V	500A to 600A 200V to 4500V

Puk





A-PUK 	E-PUK 	K-PUK 	B-PUK 	R-PUK 	W-PUK 
350A to 950A 200V to 2800V	455A to 1400A 200V to 3200V	760A to 2060A 400V to 4000V	1200A to 4535A 200V to 4000V	2325A to 8410A 200V to 5000V	7100A to 16000A 400V to 600V

Discrete Products Phase Control Thyristors

Stud

TO-48	TO-65	TO-94	TO-93	TO-118
				
10A to 40A 400V to 1600V	50A 400V to 1600V	80A to 110A 400V to 1600V	150A to 280A 400V to 1600V	300A to 500A 400V to 1600V

Puk

A-PUK	E-PUK	B-PUK	K-PUK	R-PUK
				
195A to 495A 200V to 1800V	400A to 1000A 200V to 2400V	500A to 1300A 200V to 2600V	1010A to 2100A 600V to 3800V	1940A to 4100A 400V to 5200V

The End
Thank a lot