











# PID Temperature / Process Controller

PID Temperature / Process Controller



琦勝企業有限公司  
CONCH ELECTRONIC CO., LTD.



- |  |  |  |   |  |   |
|--|--|--|---|--|---|
| <br><b>Auto-Tuning</b><br>Auto-tuning   | <br><b>Self-Tuning</b><br>Self-tuning | <br><b>Heat/Cool Control</b><br>Heating/Cooling Control | <br><b>Auto/Manual</b><br>Auto/Manual Switching | <br><b>PROG</b><br>Programmable | <br><b>°C ↔ °F</b><br>Celsius / Fahrenheit Unit Switchable |
| <br><b>HBA CT</b><br>Heater Break Alarm | <br><b>COMM</b><br>Communication      | <br><b>ALM</b><br>Alarm                                 | <br><b>RSV</b><br>Remote Set Value              |  |   |

# P Series PID Temperature Controller

- PID & Self-tuning function with 16bit microprocessor operation core.
- Various input signals for option (thermocouples, platinum resistance, analog signals, etc.).
- Main control output can be selected from relay, pulse voltage, linear analog signals so as to drive all types of contactors, SSR's, SCR's, motor valves, etc.
- Can set reverse / forward control (heating or cooling procedure).
- Dual output model can do heating / cooling two-way PID control.
- Set Value (SV) can do remote setting function (RSV) through analog signal input.
- 26 alarm modes for option. Heater break alarm function (HBA) attachable.
- Re-transmitting function can convert PV or controlling output into analog signal output for recorder or other application.
- Provides manual output mode.
- Serial communication support RTU and ASCII formats of ModBus. The maximum speed can reach 38,400bps.
- Procedure control provides 16 temperature levels. Users can plan operating blocks and repeating times.



## Product Index Code Explanation

Model	Output 1	Output 2	Alarm	Input Type	Remote SV	Transmitting Output	Communication	Power Supply	Water Proof
P10	0 Null	0 Null	0 Null	0 Thermocouple	0 Null	0 Null	0 Null	A 90~240 VAC	P Yes
P20	1 RELAY	1 RELAY	1 1 set	1 RTD	-	-	1 RS232	VAC	(Blank)
P30	2 Logic Voltage (SSR Control)	2 Logic Voltage (SSR Control)	2 2 sets	-	-	-	2 RS485	D 24~40V DC/AC	No
P50	3 4~20mA	3 4~20mA	3 3 sets	3 4~20mA	3 4~20mA	3 4~20mA			
P60	4 0~5V	4 0~5V	A HBA(50A)*1	4 0~5V	4 0~5V	4 0~5V			
Procedure Control	5 1~5V	5 1~5V	B HBA+AL2	5 1~5V	5 1~5V	5 1~5V			
P11	6 0~10V	6 0~10V	C HBA+AL2,3	6 0~10V	6 0~10V	6 0~10V			
P21	7 2~10V	7 2~10V	D HBA(100A)	7 2~10V	7 2~10V	7 2~10V			
P31	8 3-line proportional motor controlling		E HBA+AL2						
P51			F HBA+AL2,3						
P61									

\*1. If HBA function is available, AL1 function will be disabled. Select suitable amperage (50 or 100A) according to the load current magnitude.  
\*2. HBA and RSV cannot be allocated together.

## Panel Explanation for All Types

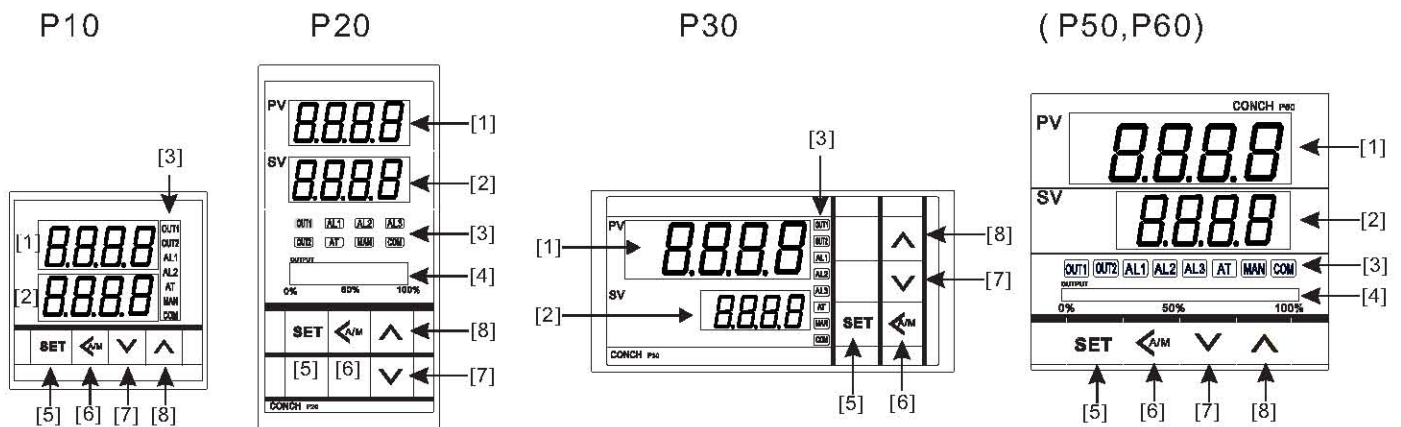

- [1]. PV(Process Variable): Displays metered value or menu in setting mode.
- [2]. SV(Set Value): Displays target value or values of parameters in setting mode.
- [3]. Status Index Lamp  
OUT1(Green)=Output 1;      OUT2(Green) =Output 2;  
AL1~AL3(Red)=Alarm;      AT(Yellow)=Auto-tuning;  
MAN(Yellow)=Manual Mode; COM(Yellow)=Communication.
- [4].OUT1: Output amount indicator (%). Shown with 10 LED .
- [5]. [SET] Key: Activates or ends parameter setting.
- [6]. [Left] Key (A/M): To move the cursor in the setting mode to change the parameter values, switch between Auto/Manual mode in display mode, or cancel Auto-Tuning operation.
- [7]. [Down] Key: To decreases parameter value at setting.
- [8]. [Up] Key: To increase parameter value at setting.

## ■ Product Specifications / Features

Model	P10	P20	P30	P50	P60
Dimension (W*D)	48X48mm	48X96mm	96X48mm	72X72mm	96X96mm
Power Supply	AC90~240V(60/50Hz), DC24V(optional)				
Power Consumption (Approx.)	4 VA	4 VA	4 VA	5 VA	5 VA
Net Weight (Approx.)	130g	200g	200g	200g	280g
Storage / Operating Environment	0~65°C/0~50°C, 20~90%RH				
Data Backup Memory	EEPROM, 10 years				
Accuracy	0.2%FS±1DIG (except thermocouple type B & S)				
Digit Height (mm)	8	8	13	14	14
PV (Red)	8	8	10	10	10
SV (Green)	8	8	10	10	10
Alarm Output	Relay contact 8A,250VAC				
Controlling Method	Controlling selection of ON/OFF, P, PI, PD, PID				
Controlling Output	Relay	A contact 5A/250V	A, B contact 8A/250V		
	Logic Voltage	PWM Pulse voltage (to drive SSR): On=24V; Off=0V(20mA Max.)			
	Linear Analog	Current: 0~20mA,4~20mA (Input impedance: 600Ω Max.) Voltage: 0~5V,1~5V,0~10V,2~10V (Input impedance: 1KΩ Min.) Resolution: Approx. 1,000 scales			
Input Type	Thermocouple	K, J, R, S, B, E, N, T, W3, W5, PL-II(Input impedance: Approx. 1MΩ)			
	RTD	PT-100(DIN),JPT-100(JIS)			
	Linear Analog	0~10mV,0~20mV,0~50mV,4~20mA,0~10V... Please refer to Input Type List.			

## ■ List of Input Type

Input Type	Code	Metering Range	Code	Metering Range	Code	Metering Range	
Thermocouple	K	K1	0.0~200.0°C/0.0~392.0°F	K2	0.0~400.0°C/0.0~752.0°F	K3	0~600°C/0~1112°F
		K4	0~800°C/0~1472°F	K5	0~1000°C/0~1832°F	K6	0~1200°C/0~2192°F
	J	J1	0.0~200.0°C/0.0~392.0°F	J2	0.0~400.0°C/0.0~752.0°F	J3	0~600°C/0~1112°F
		J4	0~800°C/0~1472°F	J5	0~1000°C/0~1832°F		
	R	R1	0~1700°C/0~3092°F				
	S	S1	0~1700°C/0~3092°F				
	B	B1	0~1820°C/0~3308°F				
	E	E1	0~800°C/0~1472°F				
	N	N1	0~1300°C/0~2372°F				
	T	T1	0.0~200.0°C/0.0~392.0°F	T2	0.0~400.0°C/0.0~752.0°F		
W	W3	0~2300°C/0~4172°F	W5	0~2000°C/0~3632°F			
PL-II	PL2	0~1390°C/0~2534°F					
RTD	Pt100 DIN	PT1	-199.9~200.0°C/-199.9~392.0°F	PT2	-199.9~400.0°C/-199.9~752.0°F	PT3	-199.9~600.0°C/-199.9~1112.0°F
		PT4	0~200°C/0~392°F	PT5	0~400°C/0~752°F	PT6	0~600°C/0~1112°F
	Pt100 JIS	JP1	-199.9~200.0°C/-199.9~392.0°F	JP2	-199.9~400.0°C/-199.9~752.0°F	JP3	-199.9~600.0°C/-199.9~1112.0°F
		JP4	0~200°C/0~392°F	JP5	0~400°C/0~752°F	JP6	0~600°C/0~1112°F
Analog Signal	10mV	An10	-1999~9999/10mV				
	20mV	An20	-1999~9999/20mV				
	50mV	An50	-1999~9999/50mV				
	Other	USER	-1999~9999/(4~20mA,1~5V,0~10V,...) (Optional)				

- Notes: 1. [Code] means changing different detecting range with the same sensor signal can be done by selecting via the panel.  
 2. The range of "Analog Signal" must be selected according to the input specification to avoid damaging the controller. The display range can be planned freely.  
 3. "USER": The type of analog input is determined at placing of order; users cannot change it.

## Alarm Output Types

There are 26 types of alarm outputs, represented with codes 00~26. 00 represents alarm disabled; odd numbers represents that the first output after start up is disabled. 25 & 26 are exclusive alarm output for process control.<sup>1)</sup>

Code 01,02: Relative high alarm		Code 03, 04: Relative deviation high
Code 05,06: Deviation low alarm	Code 07, 08: Relative deviation low	
Code 09,10: Band alarm	Code 11, 12: Low alarm	Code 13, 14: High alarm
Code 15,16: Deviation high/low	Code 17,18: Deviation low alarm	Code 19, 20: Deviation high alarm
Code 21, 22: Process low alarm	Code 23, 24: Process high alarm	Code 25, 26: Process Control

\*1.  
The control can provide at most 2~3 alarms. Each alarm has settable parameters of alarm modes and output time.  
The operations of alarm of High & Low are as follows: (taking function 02 with ALM set as 0 as example)  
High (Right) condition:  $(SV+ALM) > PV$   
Low (Left) condition:  $(SV-ALM) \leq PV$

\*2.  
If the controller is equipped with HBA (broken-line alarm) function, then AL1 is HBA output, and function code is forced as 22. Users can not change. Only delay time (A1Tr) is reserved for setting. Range: -5 ~ -1999 sec.

\*3. For models with process control, if AL1~AL3 need to be assigned to make alarm output when the program completes each level, the alarm parameter can be set as 25, and set the value of AL1~AL3 to designate level numbers (0~15).

Note: For non-process-control models, if the function code is set as 25 & 26, the alarm will be invalid.

### Heater Break Alarm (HBA):

Detects the working current of heating lines with CT and the controller judges if the heating line breaks and make alarm output. The output conditions are as below:

1. Output is at ON status.
2. Current value is lower than the set value of HBA.
3. Continues for more than (A1Tr) time. Range: -5 ~ -1999.
4. Controlling signal of Out1 must be relay or logic voltage.

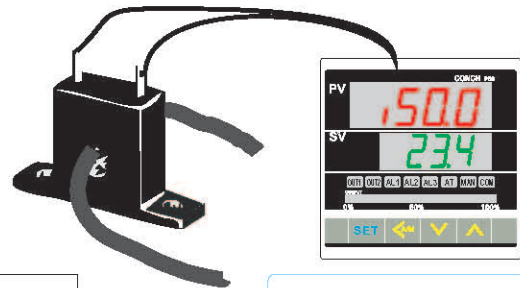

Set Current of HBA:  
The upper row displays present current value at CT (50.0A); the lower row displays set alarm value.

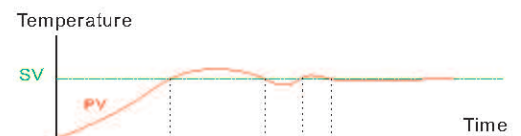
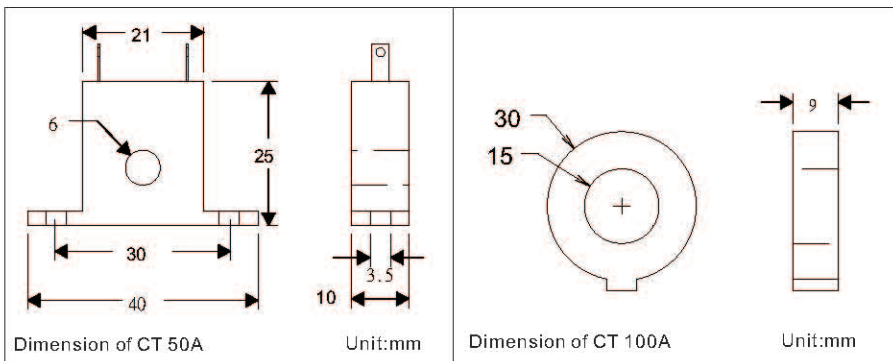

### Alarm Output Hold/Delay Time:

A1Tr~A3Tr parameters process output time controlling in accordance with each alarm. Range: -1999sec. ~ 9999sec. (except HBA). The meanings are as follows:

1. Negative value: when alarm condition is reached, delays output and self-hold.
2. Zero: when the alarm condition is reached, outputs immediately output and self-hold.
3. Positive value: outputs immediately when alarm condition is reached, and hold as long as the set time.

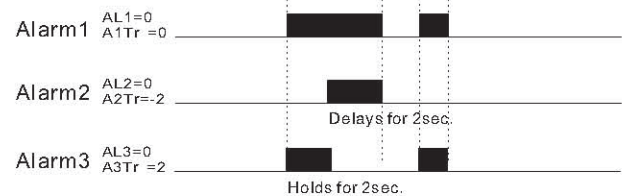

### Process Control Alarm Output: (Optional)

Except for being used as over-heat alarm, if function code (A1Fu~A3Fu) is set at 25, AL1~AL3 will output when the level is reached. By using this operation, the controller can do other applications, such as opening the furnace gate or charging process controlling, etc.

AL1~AL3 define after which level ALM outputs, and then use A1Tr~A3Tr to control the output time.

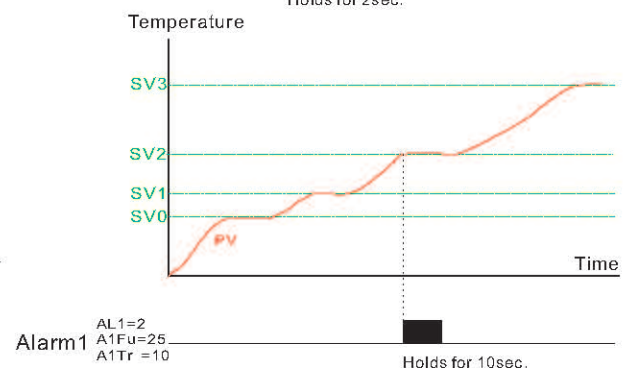

## ■Auto-tuning (AT) of PID

AT adopts Relay ON/OFF to detect the dynamic characteristics of the Process, and calculate the best parameter combination of P, I, & D according to the data. During AT, the operation must be kept under the condition where the process is not interfered.

After AT is completed (AT lamp goes off), the three parameters of P, I, & D will renew themselves, and then enter a new PID auto-control mode.

If any one of the following situations occurs, AT will stop and enter manual mode without changing values of PID:

- Any exception occurs (including power failure).
- The On or Off period of output exceeds 2 hours.
- $\leftarrow$ A/M is held for over 2 seconds. (forcing to manual mode).

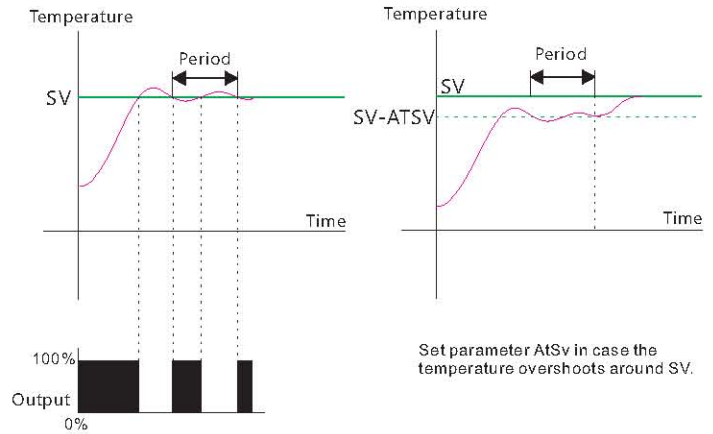

## ■Heating / Cooling Control (Optional)

Out1(heating terminal) and Out2(cooling terminal) can set gap or output overlapping via parameter "dbnd".

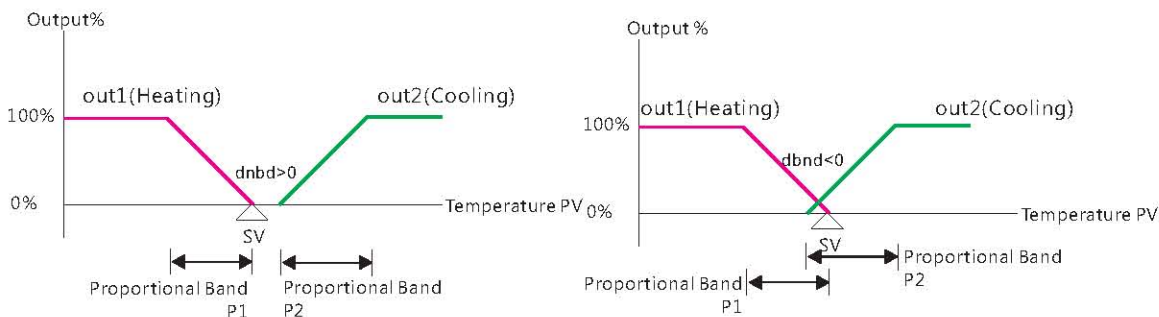

## ■Serial Communication (Optional)

Users can opt for RS-232 or RS-485 serial communication interface to connect the control with PC, PLC or HMI. Connections can be as many as 31 controllers with RS-485.

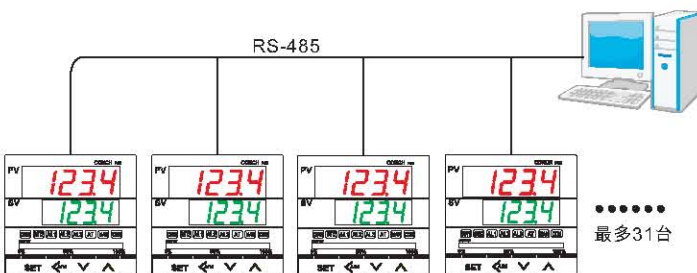

## ■Auto / Manual Shifting

In PV & SV display mode, hold A/M key for 2 sec. to switch Auto / Manual mode. In manual mode, the yellow lamp of "MAN" is alighted. Press left key to set OUT1. Range: 0.0~100.0%; OUT2 Range: -0.1~ -100.0%. To end manual mode, just hold A/M key for 2 sec. to return to auto mode.

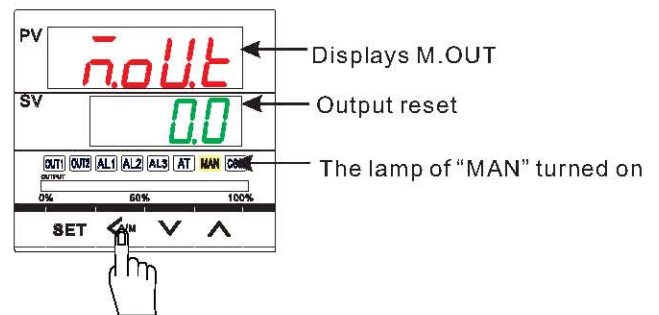

## ■Broken-line Detecting of Input Signal

When signals from the sensor of the controller fail, the temperature value will rise to the maximum value and then the controller will display "oL", then "open". ALM will adopt the highest temperature as the comparing

## ■Startup Screen

After the power supply is connected, the controller will turn on all the LED for 3 seconds to check missing segment, and then displays the maximum detecting value, code of input signal type, unit, and then enters display mode of PV & SV, and controls the value in automatic mode.

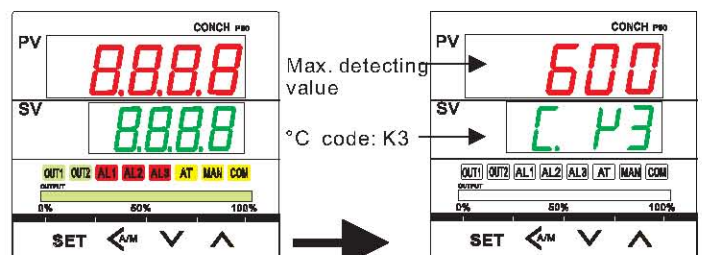
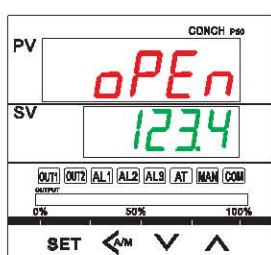

## Parameter Groups

The interior parameters of the controller can be divided into 3 groups (LEVEL1 ~ LEVEL3) according to their properties so as to make settings more convenient. The setting authorities of groups are restricted with the parameter LOCK. LEVEL1 is User's Parameter Group, the group of parameters that are changed most often. LEVEL2 is Controlling Parameter Group, which gathers parameters about auto controlling. LEVEL3 is I/O Group (input/output), which gathers such parameters as the change of sensor, adjustment of analog output, and communication. (Note: Changeable parameter series are opened or filtered according to model types or optional items.)

SV(Set Value):  
Setting of target  
value.  
Range: Sv L ~ Sv H

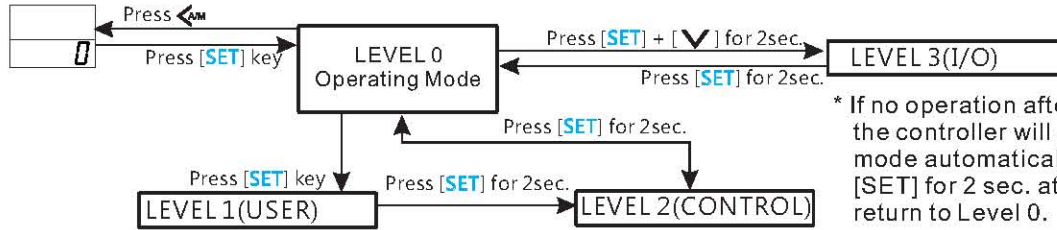

\* If no operation after 60 seconds, the controller will exit the setting mode automatically. Or, press [SET] for 2 sec. at Level 2 or 3 to return to Level 0.

### Parameters of Level 1

Display	Text	Description	Default
	AL 1	Setting of Alarm 1. Range: -1999~9999	0
	i 0.0	HBA function (optional). Alarm current is set through the lower display. AL 1 is unavailable if this function is chosen. The upper display is actual current value. Range: 0~99.9	0.0 (Ampere)
	AL 2	Setting of Alarm 2 (optional). Range: -1999~9999	0
	AL 3	Setting of Alarm 3 (optional). Range: -1999~9999	0
	At	Auto-tuning Range: No / Yes	No

The following parameters are exclusively for process control (optional)

	Strt	Setting of initiation of levels. Process starts here. Range: 0~15	0
	End	Setting of end of level. The last level of the process. Range: Strt~15 Executing intervals are defined by Strt and End.	0
	rept	Setting of repeating times of the process. Range: 0~9999(times) 0 means infinite looping.	0
	PF	Handling measure at power failure. Range: No / Yes Yes= Continues after power reconnected. No =Stops after power reconnected.	No
	Wait	Waiting temperature. When temperature reaches the deviation area, the unit will execute next process. 0 means no waiting. Range: 0~1000	0
	Sv 0	Target value of SV of Level 0. Range: Subject to specification.	0
	tr 0	Heating time of Level 0 Range: 0~6000(minutes)	10
	Ho 0	Output high limit of Level 0 Range: 0~100.0%	100.0%

Parameters of Level 1 ~ 15 are the same with the above and skipped here. Level parameters (strt ~ end) outside the area can be filtered at setting to save plan time.

### Parameters of Level 2

Display	Text	Description	Default
	P 1	Proportion band 1. Range: 0~2000 (°C,°F) or 0.0~200.0(°C,°F). 0 means controlled via ON-OFF.	6.0
	I	Integral time. Range: 0~3600sec. 0 means integration disabled and doing P-D controlling.	240
	d	Differential time. Range: 0~90sec. 0 mean differentiation disabled and doing P-I controlling.	60
	CYC 1	Cycle time of Out 1. Range: 0~120sec.	10
	Cy t	Setting of 3-line proportional valve processing time (optional) Range: 5~200sec.	20
	P 2	Proportion band 2 (optional). Range: same with P1.	6.0
	CYC2	Cycle time of Out 2 (optional). Range: 0~120sec.	10
	End	Dead band of out2 (optional): for dual output models. Range: -999~999	0
	rept	AT Offset The offset of SV at Auto-tuning. Range: 0~ 999 (0.0~99.9)	0
	HYS	Width of hysteresis. The hysteresis of output when P=0 (ON-OFF). PV>SV: Off; PV<(SV-HYS): On. Range: 0~ 900(0.0~90.0)	0
	o1Lo	Low limit of Out1. Range: 0.0~30.0%	0.0%
	o1Hi	High limit of Out1. Range: 50.0~100.0%	100.0%
	o2Lo	Low limit of Out2 (optional). Range: 0.0~30.0%	0.0%
	o2Hi	High limit of Out2(optional). Range: 50.0~100.0%	100.0%
	Soft	Setting of output softening. The higher the value is, the slower the output reaches 100%. Range: 0~20	0
	ARW	Anti-reset windup: To reduce the integral area to lower overshoot. Range: 0~100%	100%
	Self	Self-tuning of OUT 1. Range: Yes / No	No

### Parameters of Level 3

Display	Text	Description	Default
	inty	To change the type of input sensor. Range: K1~User	K3 (subject to model type)
	Pnt	Decimal Point: To set the decimal place for analog input type. Range: 0~3 (unavailable to thermocouple and PT100).	N/A
	SSEL	(Optional) To choose SV of the panel or RSV as target value.	RSV
	SvCm	QSV Compensation Quantity: Range: -999~999 (or -99.9~99.9).	0
	PvCm	PV Compensation Quantity: Range: -999~999 (or -99.9~99.9).	0
	A1Fu	Function of Alarm 1: Refer to Alarm Output. Range: 00~25	2
	A1Tr	Time of Alarm 1. Range: -1999~9999sec.	0
For models with multiple alarm outputs, there are still settings for A2Fu, A2Tr, A3Fu, A3Tr, whose functions are the same with the above and are omitted here.			
	AHYS	Alarm Hysteresis: Functions are at single side 17 ~ 24 of alarm function (off delay). Range: 0 ~ 1000.	0000
	in1L	Setting of low display for analog input. (Optional) Range: -1999~9999.	0
	in1H	Setting of high display for analog input. (Optional) Range: -1999~9999 -	1000
	Sv L	Setting of Low SV. Range: subject to input signal.	0
	Sv H	Setting of High SV. Range: subject to input signal.	600
	in2L	Setting of low display for Input 2 (RSV, optional): Range: -1999~9999.	0
	in2H	Setting of high display for Input 2 (RSV, optional): Range: -1999~9999.	600
	Co1L	Calibration of Low of Analog Output 1: Range: 2~9000	N/A
	Co1H	Calibration of High of Analog Output 1: Range: 0~4000.	N/A
	Co2L	Calibration of Low of Analog Output 2: Range: 0~9000 -	N/A

Continuing left column:

Display	Text	Description	Default
	Co2H	Calibration of High of Analog Output 2: Range: 0~4000	N/A
	o3ty	Target of retransmission (optional): Range: PV, OUT1, OUT2	PV
	Co3L	Calibration of Low of retransmission (optional): Range: 0~9000	60
	Co3H	Calibration of High of retransmission (optional): Range: 0~4000	10
	O3 L	Setting of Low display of retransmission target (optional): Range: -1999~9999	6.0
	O3 H	Setting of High display of retransmission target (optional): Range: -1999~9999 -	10
	Unit	Unit setting: Range: C or F	C
	dir	Direction controlling: Range: heat / cool Unavailable to dual output model.	Heat
	P Hz	Power Frequency: Range: 50 / 60 (Hz)	60Hz
	FiLr	Parameter of digital filter: Range: 0.01~9.99 The greater the value is, the slower the PV changes.	2.00
	Id	Communication ID (optional): Range: 0~99	1
	baud	Baud rate: Range: 2.4, 4.8, 9.6, 19.2, 38.4 (KB/s)	9.6
	data	Serial communication data format: Range: 8n1, 8n2, 8e1, 8o1	8n1
	Mode	ModBus communication format: Range: RTU / ASCII	rtu
	tout	Communication time-out: Range: 5~99sec.	5

### ■ Panel Operation for Process Control (Optional)

- Press **▲** key to start the process.
- Press **▼** key to pause.
- Hold **▼** + [SET] to stop.
- Hold **▲** + [SET] to skip to next level.

#### Parameter Lock Setting

Press [SET] + [**▲**] for 2 sec.

- 0: To disable settings of all parameters.
- 1: Only setting of SV is available.
- 2: Only Level 1 and Manual/Auto function are available.
- 3: Level 1 & 2 are available.
- 4: Settings of all parameters are available.

End. Returns to display mode.

## ■ Dimension & Panel Cut-out (mm)

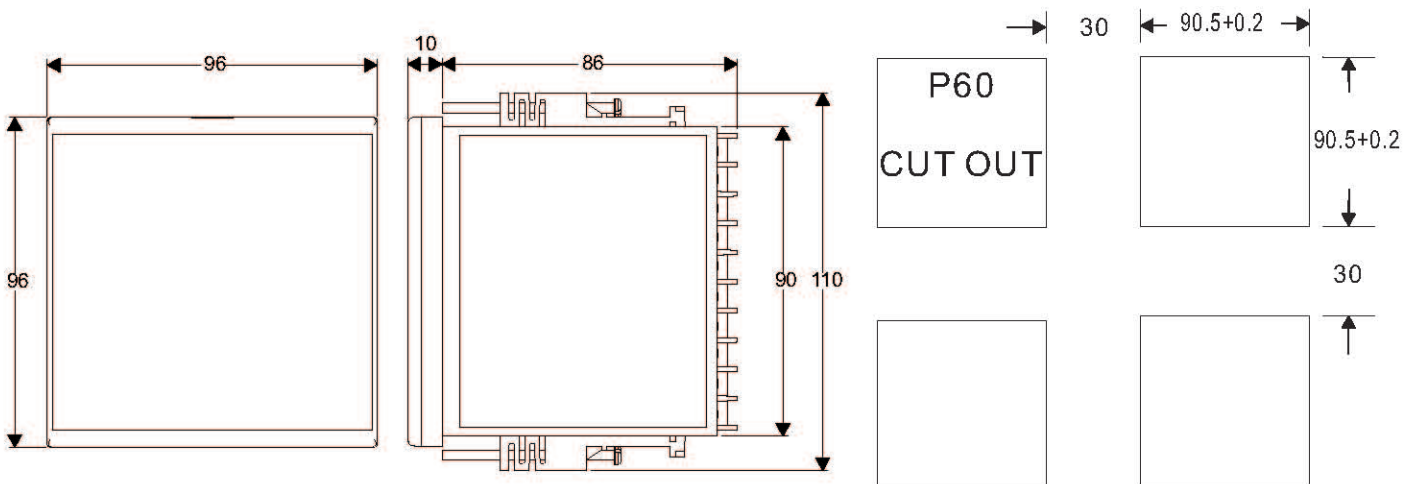
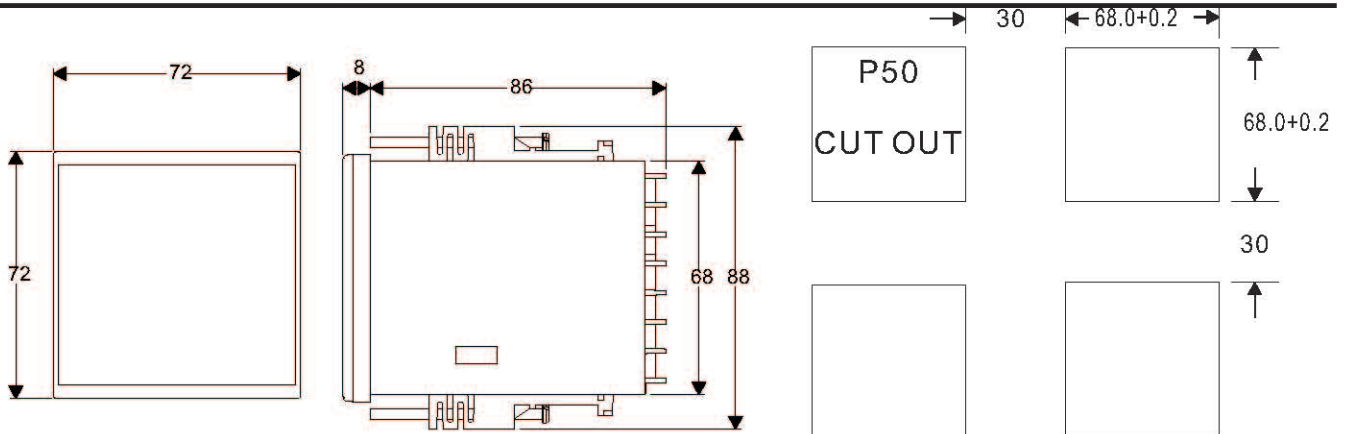
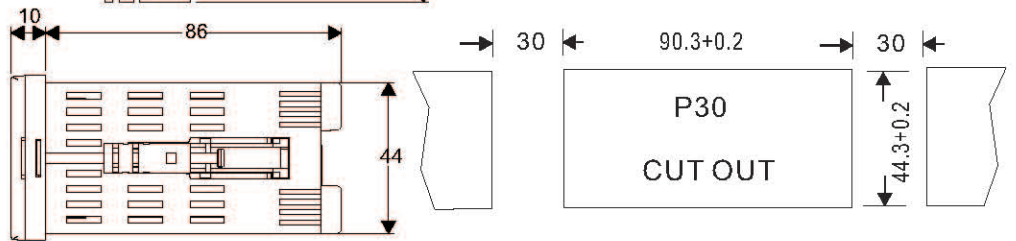
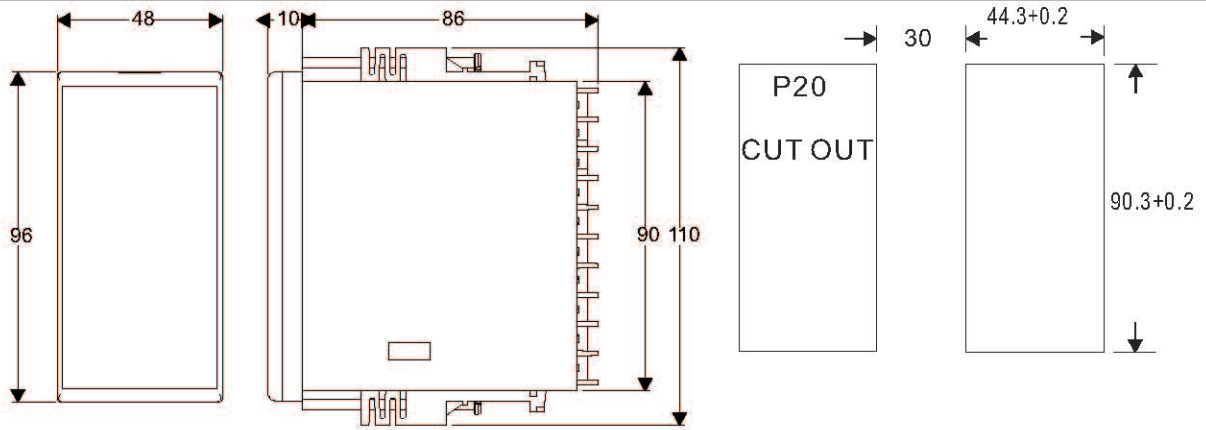
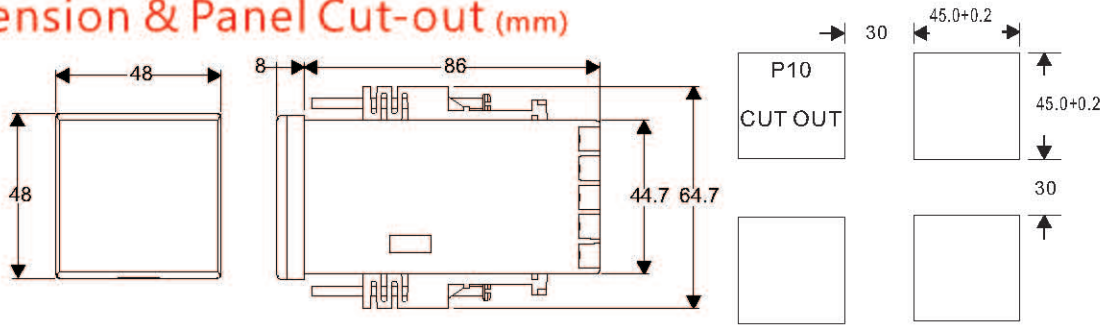



# ■ Wiring Diagram

Note: If defined terminal repeats terminals of other functions. Only one function can be selected. If power supply is 24V AC/DC, polarity can be disregarded at input terminal.

## P10 Terminals

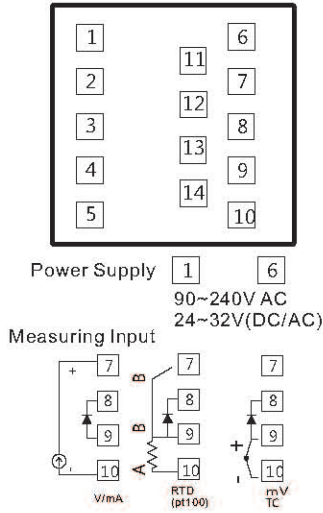

OUT1	OUT2	AL1	AL2	AL3	RSV Input	CT Input	Retransmission Output	Communication
4 Relay SSR V/mA 5		2 3			11 V/mA 12	11 CT 12	11 V/mA 12	11— Rx Dx- 12— Tx Dx+ 13— SG RS232 RS485
3 CLOSE 4 OPEN 5 COM	2 Relay SSR V/mA 3	13 14	13 14					11— Dx- 12— Dx+ RS485

## P20,P30 Terminal

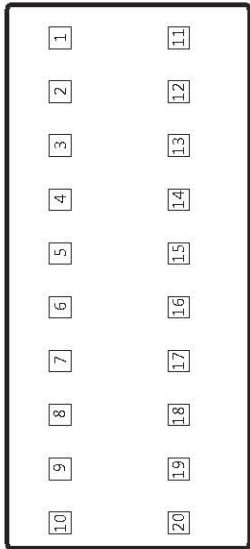

OUT1	OUT2	AL1	AL2	AL3	RSV Input	CT Input	Retransmission Output	Communication
8 Relay 9 SSR V/mA 10 COM		3 NC 4 NO 5 COM	11 NC 12 NO 13 COM	6 7	14 V/mA 15	14 CT 15	12 V/mA 13	14— Rx Dx- 15— Tx Dx+ 16— SG RS232 RS485
7 CLOSE 8 OPEN 10 COM	6 Relay SSR V/mA 7	3 NC 4 NO 5 COM	11 NC 12 NO 13 COM	Measuring Input Power Supply 17 18 19 20 V/mA RTD (pt100) mV TC 90~240V AC 24~32V(DC/AC)				11— Rx Dx- 12— Tx Dx+ 13— SG RS232 RS485

## P50 Terminal

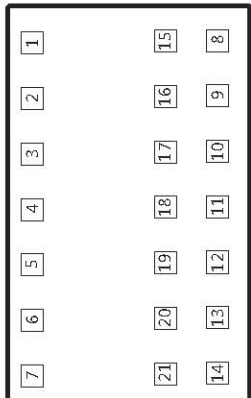

OUT1	OUT2	AL1	AL2	AL3	RSV Input	CT Input	Retransmission Output	Communication
5 Relay 6 SSR V/mA 7 COM		3 4	8 COM 9 NO 10 NC	20 21	9 V/mA 10	15 CT 16	18 V/mA 19	15— Rx Dx- 16— Tx Dx+ 17— SG RS232 RS485
4 CLOSE 5 OPEN 7 COM	3 Relay SSR V/mA 4	20 21	8 COM 9 NO 10 NC	Measuring Input Power Supply 11 12 13 14 V/mA RTD (pt100) mV TC 90~240V AC 24~32V(DC/AC)				15— Rx Dx- 16— Tx Dx+ 17— SG RS232 RS485

## P60 Terminals

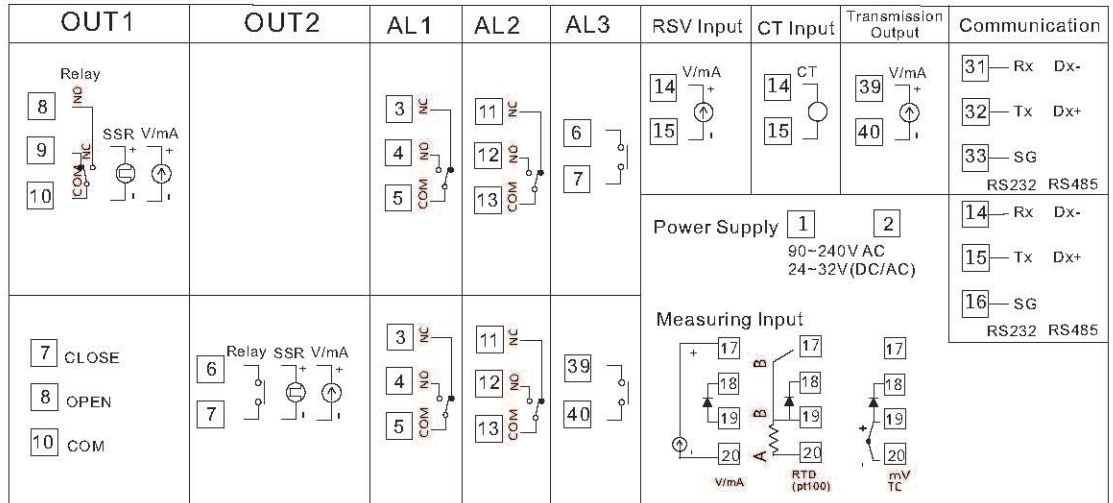
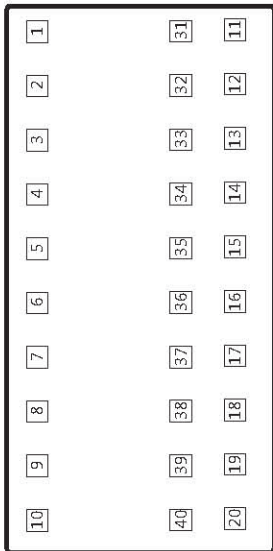

### ■ Error Message

- oL** "Overload." PV is above the high input display range limit. Please check if the input signal is correct.
- oL** "Underload." PV is below the low input display range limit. Please check if the input signal is correct.
- oPEr** Input signal broken. Please check if the wiring is loosed or the polarity is reversed.
- CJEr** Error to the temperature sensing diode for cold-junction compensation of the thermocouple. Please check if the diode is loosed. If it is broken, please send it back for repairing.
- AdEr** Interior circuit error. Please send it back for repairing.

### ■ Mounting Diagram

There are 2 methods to mount the controller.

1. (Figure Mount-1) First, mount the controller to the read-cut panel. Then, insert the fixing racks to the side gaps of the controller. Last, push the rack forward until it is fixed. (Or, rotate the screw until it reaches the panel. Then, use the screwdriver to tighten it.)
2. (Figure Mount-2) Push the fixing rack backward, and then tighten it forward with screwdriver.

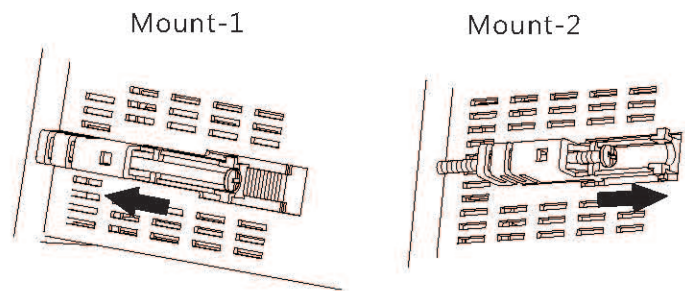

## ■ Temperature Sensor Specification

Note:

1. When extending the temperature sensor, please use compensating wire of the same specification for the thermocouple. For RTD, please use low-impedance wire.
2. If possible, do not wire the temperature sensor with the power line.

KP 1 - 2 3 4 5 6 7 8 9

1 Appearance	2 Sensor Type	3 Fixing Thread	4 Diameter of Shielding Tube	5 Tube Length	6 Tube Type	7 Wire Length	8 Wire Type	9 Insulation Type
	K: Thermocouple Type K	0: N/A	N: N/A	000: N/A	N: N/A	00: N/A	N: No compensating wire	N: Grounding type
1: Thread Type	J: Thermocouple Type J	1: 1/4"-20NC thread	A: 1.6Φ	050: 50mm	A: SU304	01: 0.1M	A: Metal lattice 1/0.65	Y: Non-grounding type
2: Climbing type	P: PT100 (DIN)	2: M6 thread	B: 2.3Φ	100: 100mm	B: SU316	05: 0.5M	B: Metal lattice 4/0.32	
3: Climbing type with 90° turning	B: Thermocouple Type B	3: 5/16"-24NF	C: 3.2Φ	200: 200mm	C: Teflon tube	10: 1.0M	C: Fiberglass 4/0.32	
4: Inserting type	R: Thermocouple Type R	4: PT 1/8" inclined thread	D: 4.0Φ	300: 300mm	D: Ceramic tube	20: 2.0M	D: Fiberglass 4/0.65	
5: Small round head	S: Thermocouple Type S	5: PT 1/4" inclined thread	E: 5.0Φ	400: 400mm	E: Sheathed <sup>*2</sup> (SU316)	30: 3.0M	E: PVC line 4/0.32	
6: Large round head	T: Thermocouple Type T	6: PT 3/8" inclined thread	F: 6.4Φ	500: 500mm		50: 5.0M	F: PVC line 4/0.65	
7: Large round head with dual output		7: PT 1/2" inclined thread	G: 8.0Φ				G: Teflon 1/0.65	
8: Small T head		8: PT 3/4" inclined thread	H: 9.5Φ				H: Teflon 7/0.32	
8: Large T head		9: Pressure-resistant adaptor <sup>*1</sup>	I: 12.7Φ				I: 3-core PVC cable for PT100	
			J: 15.0Φ				J: 3-core Teflon cable for PT100	
			K: 17.3Φ					
			L: 20.4Φ					

(\*1): Pressure-resistant adaptor can work with the temperature sensor of inserting type so as to adjust inserted length and then be fixed.

(\*2): The tube diameters(Φ) applicable to Sheathed type are: 1.6, 2.3, 3.2, 4.8, 6.4, 8.0

Note 1: PVC cable has heat tolerance up to 80°C and moisture resistance; the tolerance of fiberglass can reach as high as 200°C, but it is not moisture resistant; Teflon is heat-resistant as high as 200°C, anti-erode, and moisture resistant, with better advantages in every aspect.

Note 2: Non-grounding type has better ability of interference resistance, but is slow in responding; the ground type is exactly the reverse instead.

Sheathed type has such advantages like fast response, high insulation, bendability, and pressure tolerance.

Note3: In addition to the type above, customized design is accepted.

## ■ Temperature Sensor Dimension

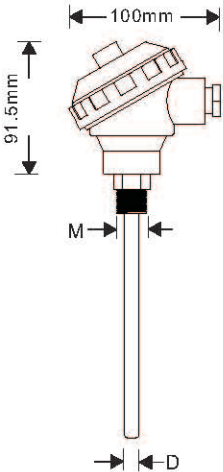
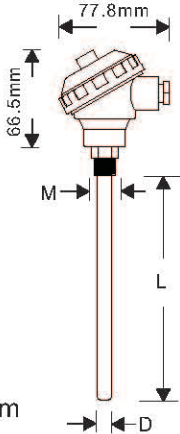
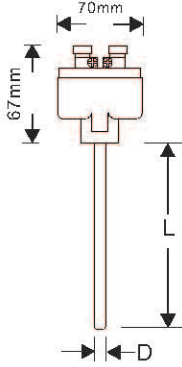
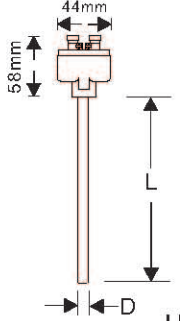
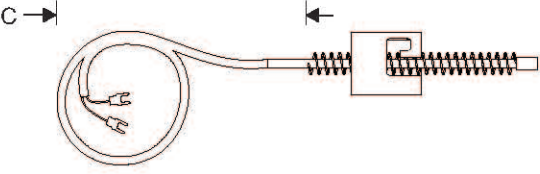
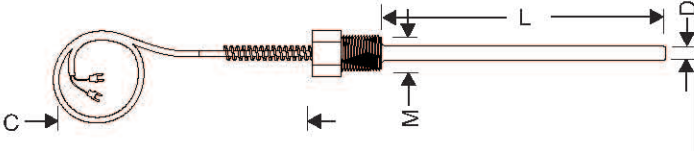
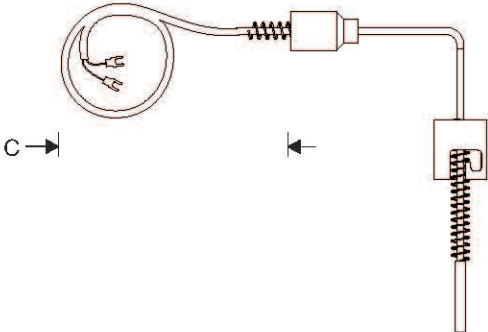
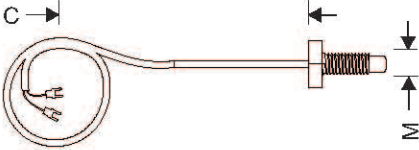
Large round head	Small round head	Large T head	Small T head
			
Unit: mm		Unit: mm	
Clinching type		Inserting Type	
			
Clinching type with 90° turning	Threaded type		
			

### Size Code:

C: Length of line. Refer to Specification Column [7] of Pg. 10.

L: Length of shielding tube. Refer to Specification Column [5] of Pg. 10.

M: Fixing thread. Refer to Specification Column [3] of Pg. 10.

D: Diameter of shielding tube. Refer to Specification Column [4] of Pg. 10.



Surface Detecting Type



Freezer Type



Insertion Type (KP4)



Sheathed Type



Insertion Type (KP4)



Insertion Type (KP4)



90° Clinching Type (KP3)



Insertion Type (KP4)



Large Round Head (KP3)



Small Round Head (KP5)



Small T Head (KP8)

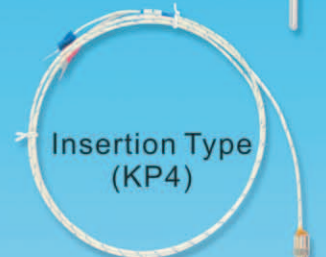

Insertion Type (KP4)



Fastening copper base for clinching type



Insertion Type (KP4)



Pressure Adaptor

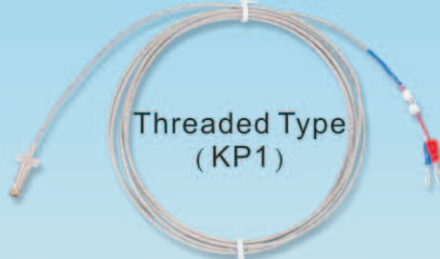

Threaded Type (KP1)



Threaded Type (KP1)



Clinching Type (KP2)



K (Male & Female - Large)



K (Male & Female - Small)



琦勝企業有限公司  
CONCH ELECTRONIC CO., LTD.

| Headquarters 總公司

70955 台南市安南區科技一路3號

統一編號(VAT No.) : 22506215

Add: 3 Keji 1<sup>st</sup> Road,

Tainan 70955,

Taiwan

TEL:886-6-3842111

FAX:886-6-3840855

Website: [www.conch.com.tw](http://www.conch.com.tw)

E-mail:[conchltd@ms24.hinet.net](mailto:conchltd@ms24.hinet.net)

| 台北營業所 Taipei Office

台北縣中和市建八路2號12樓-3

TEL:886-2-82262211

FAX:886-2-82261212

| 台中營業所 Taichung Office

台中市南屯區大富街118號

TEL:886-4-23868555

FAX:886-4-23864810

| 上海分公司 Shanghai Branch

TEL:86-21-54399660/54392560

FAX:86-21-64543550