

Friday, April 19, 2013



**HCC (Specialty Products) LLC**

LOGO

# **HCC (Specialty Products) Limited Liability Corporation**

**HCC (Specialty Products) LLC it a Consumer Products Manufacturing Corporation, HCC it the initial of the owners and (Specialty Products) (Specialty Products) this company will be doing the specialty stuck the product that other have on the shelve known in they can make a lot of money from the sale of if they could find a way to do them! As these are! Those type of products no one else can do them if any one try to sell you these product they breaking the law and it should be reported to meat ones that they selling theses they breaking the law**

**LLC it a Limited Liability Corporation it will have insurance for it customer, that it if you hurt but any of the product make by this company their insurance to cover you injured just have to prove to the insurance company that you were injures by us and they have set feed**

**for injures, like most in insurance company lose a hand or a foot there are set amount they pay if this company injures you in any way with it products, and you will not be dealing with this company if you set for injures you will be dealing with a insurances company instead OF HCC ( Specialty Products ) LLC but if your injures there will be insurance to take care you if you hurt by any of these products we intend our customer service to be surpass by no one as the design of our product will not the services will match the products**

**The new technology need to make these products available to you was developed by the owner and inventor of this corporation**

**The most need consumer products today available here today form this company only The household chicken a food processor for processing cutting up birds and chicken design and invented to save you money on your food bills, the energy saver doors and screen doors design and invented to save you money on your heating and cooling bills and repair of your homes, the floor vents and grates design and invented to save you money on your heating and cooling bills, the dry wall restore design and invented to save you money on wall repair home improvement and repair, the hand saver wrench design and invented to save you money on auto repair and too allow professional who repair auto too get more work done in a day and their fore make more money by increasing the number of jobs they can do to increased their profit, the poetry book poem of the light wrote to inspire people to check out the Christian a god and his think**

**I do grantee these product at the prices mention not only that, but assure they will pass and ahead to all the below certification before delivery to you company or site Certification: CE FCC FDA GS CCC CB**

**HACCP RoHS UL CSA C-TI CK SAA SGS PSE MIC-Mark EK-Mark  
VDEaol.com;**



**Signature:**

**Contact me below company web in process not finished yet**

**Thank**

**Harold C Christian**

**E-mail: [hccspecialtyproductllc@aol.com](mailto:hccspecialtyproductllc@aol.com) or**

**[hccspecialtyproductsllc@live.com](mailto:hccspecialtyproductsllc@live.com) and**

**[hccspecialtyproductsllc@yahoo.com](mailto:hccspecialtyproductsllc@yahoo.com)**

**Owner and President /Inventor/ Designer**

**Of**

**Thank Harold C Christian**

**Owner and President /Inventor of HCC (Specialty Products) Limited  
Liability Corporation I.D (340-032-2) Temp address below for startup  
paper work to get registration so I could get a tax's**

**To contact by mail other used e-mail address on catalog**

**E-mail: [hccspecialtyproductllc@aol.com](mailto:hccspecialtyproductllc@aol.com) or**

**[hccspecialtyproductsllc@live.com](mailto:hccspecialtyproductsllc@live.com) and**

**[hccspecialtyproductsllc@yahoo.com](mailto:hccspecialtyproductsllc@yahoo.com)**

**1053 Fairwood Lane Olathe, Kansas, 66061**

**Phone 1-434-846-7230 As for the phone number here it a family member who can get in touch with his sister who can get in touch with me if necessary he has nothing to do with this company, simple taken messages, but the day you deposited you letter of credit and the bank get in touch with me you have normal communication will go in place you get a call and all the normal communication between you company and mine will go in places**

## **Process for Start-up and Set- up to Accomplished Stabilization**

**the products being made in the country of China the household appliance all models, and the book being printed their the energy saver vent it being toll and modeled there, also the socket for the wrench set being modeled there, as you can see the vendor are from their making most of the components for startup I can get your their name if need all set up and bid in and selected start will be easy really and the tool for the dry wall restore and patch made their also, I've also component manufacture of the mess and paper line up for the dry wall patch and restore form all over including Viet Nam and other obviously if all order flow into the bank there will be multi plus vendor for all those think many have limited that we required more than they can made as to multi-vendor for all this stuck startup will be easy just mostly assembly at my home pant except for the doors and the extension for the wrench set will be total manufacture at my corporate headquarters and start ship plant were every that be it will be decide after start letter of credit are in the bank of which I will be using the bank of china for my corporate bank of which I know I other company can used that or any other bank on the plant that legist I leave the legist think up too you them the bankers, do not contact me put your**

**order and letter of credit in the any of you choice contact my bank they will be collecting the money if you bank if suitable to them it suitable to me, let them contact me , with an ax copy of the letter of credit to sign we start the process this until start over then if you prefer when regular communication are set up contact me but you will be dealing with my corporate bank anyway too get this process started , done this many time working for the company here command place to do it this way**

**What the hold waiting on you buy these product especially the one who send inquired asking permission to buy these product and it been given but just disappear with no expert nation at all**

**Simple send your order to and proof of pay to my corporate bank listed in my catalog they will fax a copy to my location where I meet with a banking official sign the letter of credit paper work then your get your product a fax copy remember it as good as a hard copy anywhere, then I goes the bank I the information concern in vendor and my hole plan to get these too you and we get started on the work as you can see with the vendor already pick and with the little fabrication I be doing in this startup of my own employee that the suck that old not being done in another location but completed fabricated at my plant that not of the shelve or simple haven to stay on top of a vendor to make sure they get the component they building right start will be very easy and you probably see them being ship to you in around 45 days**

**Sincerely**

**Harold C Christian**



**Signature:**

**Delivery Time for All Products  
Are as shown no exception**

**About 45 days on all products except the books 30 days should start to ship in about 30 days**

A handwritten signature in cursive script, appearing to read "Harold C. Christian". The ink is black and the signature is fluid and connected.

**Signature:**



*Handell Chilton*

**book \$45.00**

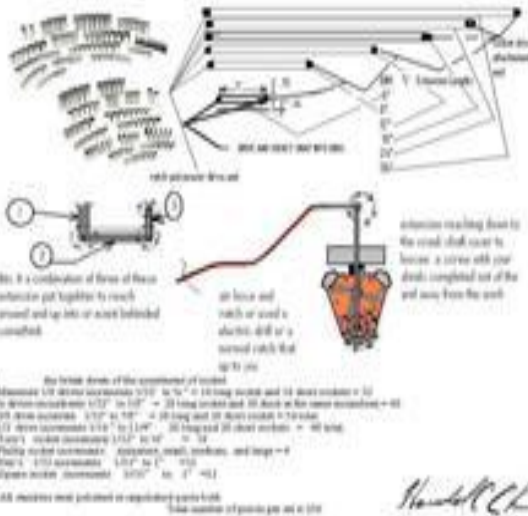

*Handell Chilton*

**hand saver socket wrench set \$135.00**

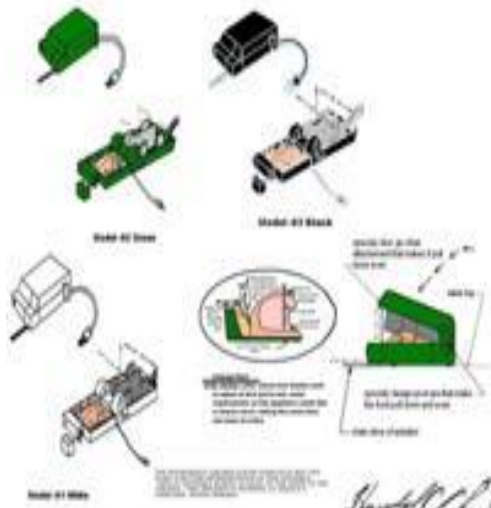

*Handell Chilton*

**chicken cutter \$125.00**

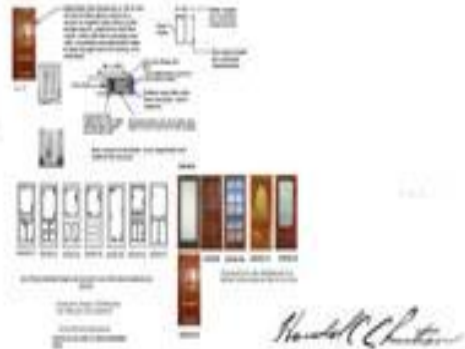

*Handell Chilton*

**energy saver door \$175.00**

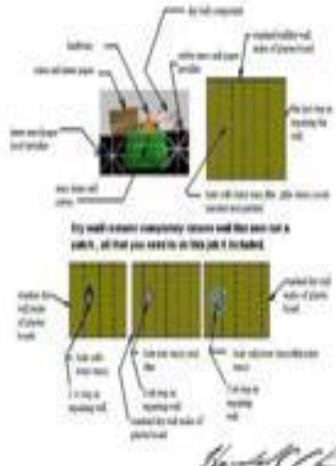

*Handell Chilton*

**dry wall restorer \$29.95 | \$ 49.95**



HCC (Specialty Products) LLC

*Handell Chilton*

**energy saver vent \$9.95**

**HCC(Specialty Products) LLC product list and prices**

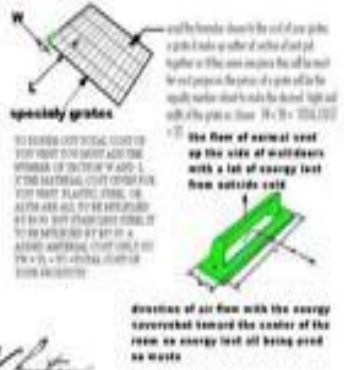

## **The Household Appliance Division**

**The new technology need to make this product available to you was developed by the owner and inventor of this corporation, All engineering and design work it done to create this technology, now to order simple send purchase order and deposited proof of payment in the form of a letter of credit in some bank and inform me and my corporate bank what and where the proof of payments it so we can verify it**

## **The Household Chicken Cutter: Patent pending # 1890)**

**An electronic household appliances)**

**White Model No. 340032-2008-1 EUR 125.00 or \$163.75**

**Black Model No. 340032-2008-2 EUR 125.00 or \$163.75**

**Green Model No. 340032-2008-3 EUR 125.00 or \$163.75**

**Prices includes instruction book, coupons and a small cook books 2 set of Blade plus a specialty spoon to remove chicken and shipping paid on all replacements due to default products or workmanship These products will cut up a whole fryer or chicken within 27 seconds or less with just the push of a button. They are Table top appliance about the size of a toaster oven or a Little Larger with fit a whole a chicken or small turkey Will cut in four different Blade arrangements this chicken cutter will save you \$ 2.50 to \$ 3.00 per. Chicken or bird in us dollar, that the different between What you would pay for a chicken or bird in the store in The us if you brought one already cut – up, but why do that when this machine will do it in 27 seconds Saving you All that money and work, and time, how could you customer Resisted this and As soon as your order I'll bring Case Engelen the President of Titoma who has 4 plants and A manufacture group there in Taiwan waiting to get started In the process of building**



**theses but you must contact me First because of a none discloser contract you could add As a market up of \$ 25.00 or more to this, you decide You know your clientele more than I'm this appliance Will still have jump off the shelf, and be below most Product**

**That are already setting in their house such as Coffee pot, that sell for \$300 or more and convection oven That sell for \$165.00, products that have everyone already has even with this Unheard of market-up for retail stores they still fly off The shelves, when your normal mark-up for Something likes \$5.00 dollar, not \$25.00 or \$30.00 and still below product that just hit one of the normal Requirements for a good consumer product, saving time,**

**Products will be made of food contact stainless steel and Plastic, There will also be three other different colors, This is the most need appliance for the home maker in Today's world, it actually will do the only task that the Home maker doesn't have a machine or some appliance Already to do that labor intense and costly and hard work, And dose it in 27 seconds, Notice the sale prices of the whole fryer a \$0.39 to \$0.50 saving per lb.**

**These product will go thru a endurances test here in America all household appliance will have to pass a 500 hour continually running test without failure so will all my product conform the that as a minimal standard Including no rust or degrade of material performances, electric chock or shorts or any kind of electrical problem that can cause fire or any kind of electrician situation or food contamination but go thru the rest not fail in any of these doing or after the test finished in order to pass, other words at the end of test these appliance must be operational without any problems**

**These test and grantee are made by the manufacture of these products over**

**News flash how true it what I said they so affair of you list en they trying to get me lock up again used my intelligent and avoid the individual out the blue had serious problem with me which means he someone send too actually pick a fight trying to get you in trouble it**

**what they do too you so you're not around like when they post that letters of credit for the household appliance to get set up out of here over there would be doing but you see they done so ,much I expect it when i closed to winning , being a ex veteran you must be carefully if you used violence's on a surf villain that you had no other coursed but too in order to save your life because of the hand to hand combat training you have but they try too induces fight to get you out of commission at time lie these but your see i aware of that can easy avoid such thinks, so good ahead post those letter of credit as you can see especially you super stores in Europe it only EUR 1,673,500.00**

**I a manufacture in Taiwan ( Titoma ) who done not need to set up a plant all ready to tool this up and start production which get product to start shipping to you in these within 45 days for this household appliance it just take an order of only 10,000 pieces get that start , that was supposed to be the front line product to get out on the shelve first in the store fund all the rest with those profit but sine I been delayed starting every think up together looking forward to you getting that letter of credit information to the bank of china so we can start , this quaintly of product will allow tooling cost and my cost too relocate over there and get every think else I need done here and there to accomplished completed started of all products as plan originally Customers of these supper store in Europe you know that just a EUR 1,673,500.00 not even a sample order for one of them and a few if you could have these product these appliance in the store on the way to you in 45 days, and the ensuing process my whole company would get set up and you spend years with new product s flown out to the shelve as long as I am able to do it really**

The screenshot shows the Allrecipes website interface. At the top, there is a navigation bar with links for Recipes, Menus, Tips & Advice, NEW! Community, and Shop. Below this is a search bar with the text 'Search Allrecipes.com' and a 'Search' button. A sidebar on the left lists 'Related Tips & Advice' including 'Tips and Advice', 'Cooking School', 'How-Tos', 'Meats & Grilling', 'Budgeting', and 'Photo Tutorials'. The main content area features a large image of a whole chicken on a cutting board. To the right of the image is the title 'Cutting Up a Whole Chicken' and the byline 'By: Allrecipes Staff'. Below the title is a short introductory paragraph: 'It takes more than one go at cutting up a chicken to become an expert. However, once you've got the hang of it, you can cut up a chicken in very little time and with hardly any effort at all! Perhaps the most important reason to learn how to cut up a whole chicken is that it will save you money. Buying a whole chicken is cheaper than buying pieces, and the leftover parts are ideal for forming the backbone of soup stocks. The same method can be used for cutting up other fowl like duck or squab.' Below the text are four numbered steps, each accompanied by a small image showing the step in progress: 1. Place the chicken breastbone-side up on a clean, flat cutting surface. 2. Use a standard, sharp kitchen knife to slice off the wing joints. The wings can be set aside and reserved for stock. One breast and leg is removed at a time. Follow steps 3 through 5 to remove the breasts and legs. 3. Make a shallow incision running along one side of the breastplate. 4. Deepen the incision by slicing into the chicken toward the rib cage. Pull the meat away from the rib cage as you slice down. As you progress further into the bird, slide the knife off of the rib cage repeatedly to ensure that you are removing any

TIME SAVED

**You know my wife worked in retail and with an end cap a big open sale to blow out your first shipment with a TV demo going the woman will be fighting over this appliance no one will want to wait for a rain-Check**

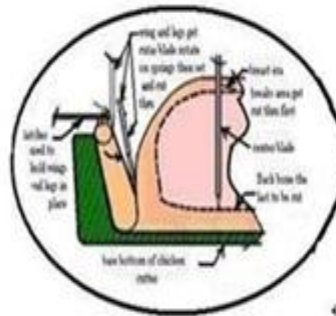
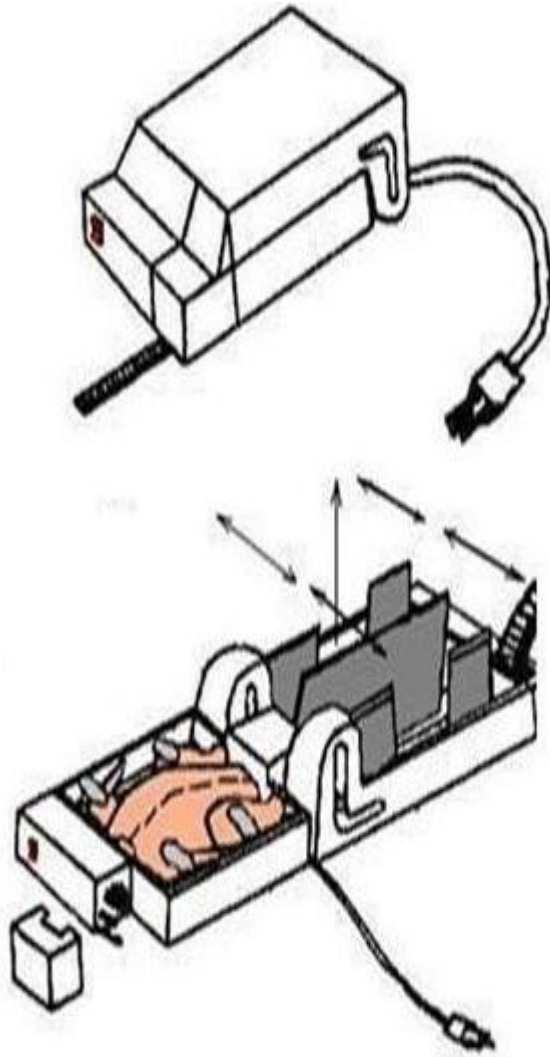

**Enlarge View**  
of the chicken cutter shown how blades work to adjust of bird and to min. motor requirements so this appliance works like a chainsaw never cutting thru more than one bone at a time

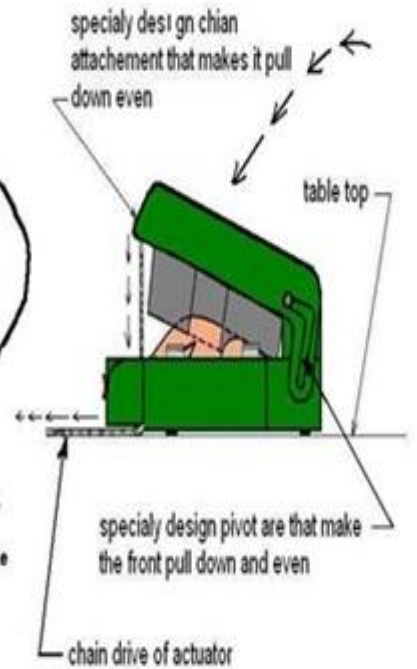

THE HOUSEHOLE CHICKEN CUTTER SKETCH IT NOT TOO SCALE A PICTURE REPRESENTATION OF THIS APPLIANCE WITH IT ADJUSTABLE BLADES TO ADJUST TO THE SHAPE OF THE CHICKEN , THIS APPLIANCE IT PATANTED TO HAROLD C CHRISTIAN PATENT PENDING

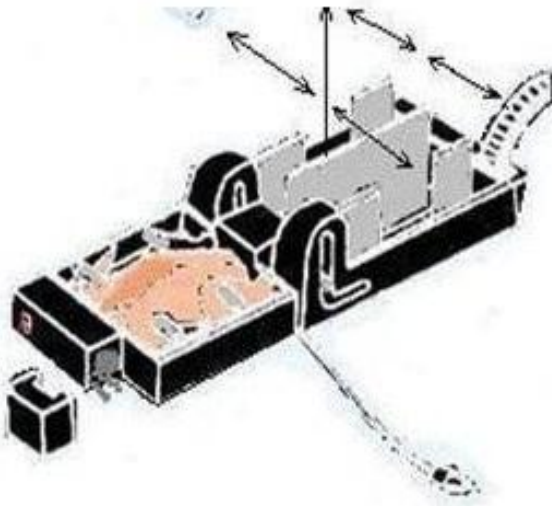
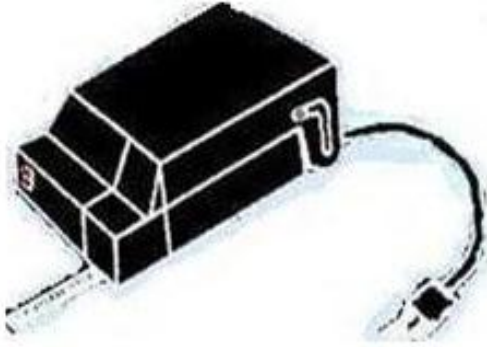

### Model -03 Black

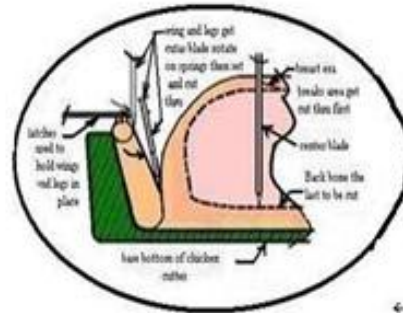

**Enlarge View**  
 of the chicken cutter shown how blades work to adjust of bird and to min. motor requirements so this appliance works like a charme never cutting thru more than one bone at a time

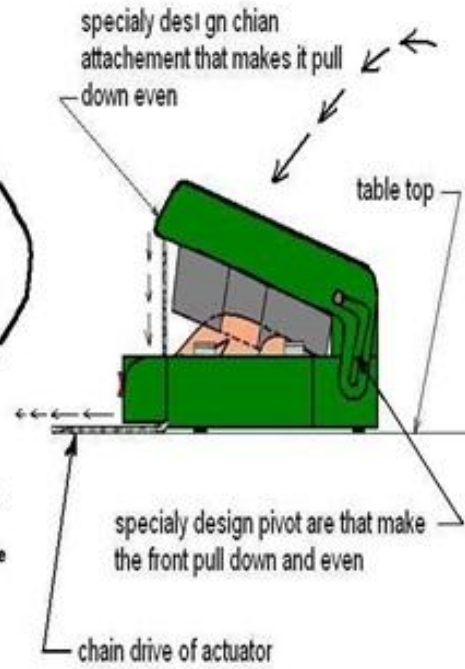

THE HOUSEHOLE CHICKEN CUTTER SCHETCH IT NOT TOO SCALE A PICTURE REPERSENTATION OF THIS APPLIANCE WITH IT AJUSTABLE BLADES TO AJUST TO THE SHAPE OF THE CHICKEN , THIS APPLIANCE IT PATANTED TO HAROLD C CHRISTIAN PATENT PENDING

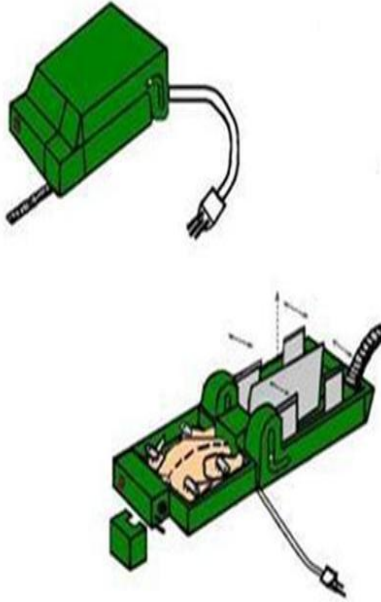

**Model -02 Green**

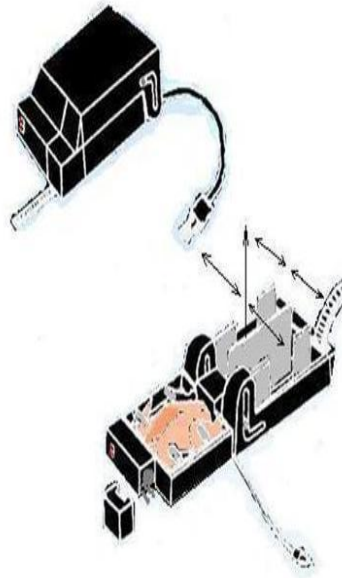

**Model -03 Black**

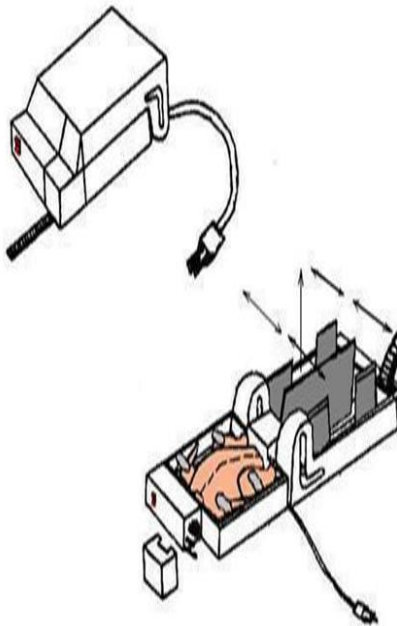

**Model -01 White**

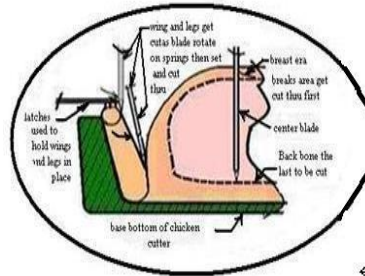

**Enlarge View**  
of the chicken cutter shown how blades work to adjust of bird and to min. motor requirements so this appliance works like a charme never cutting thru more than one bone at a time

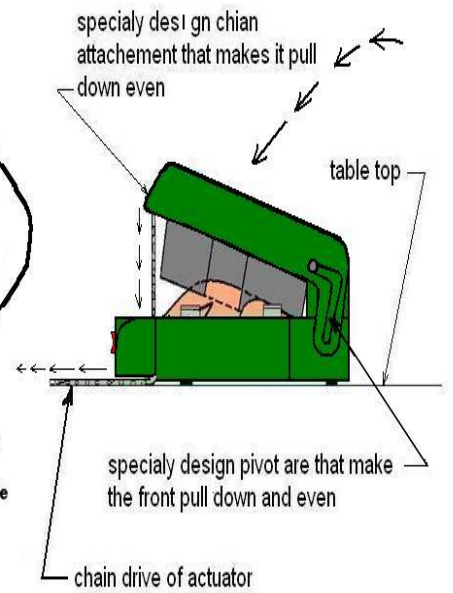

THE HOUSEHOLE CHICKEN CUTTER SCHETCH IT NOT TOO SCALE A PICTURE REPERSENTATION OF THIS APPLIANCE WITH IT AJUSTABLE BLADES TO AJUST TO THE SHAPE OF THE CHICKEN , THIS APPLANCE IT PATANTED TO HAROLD C CHRISTIAN PATENT PENDING

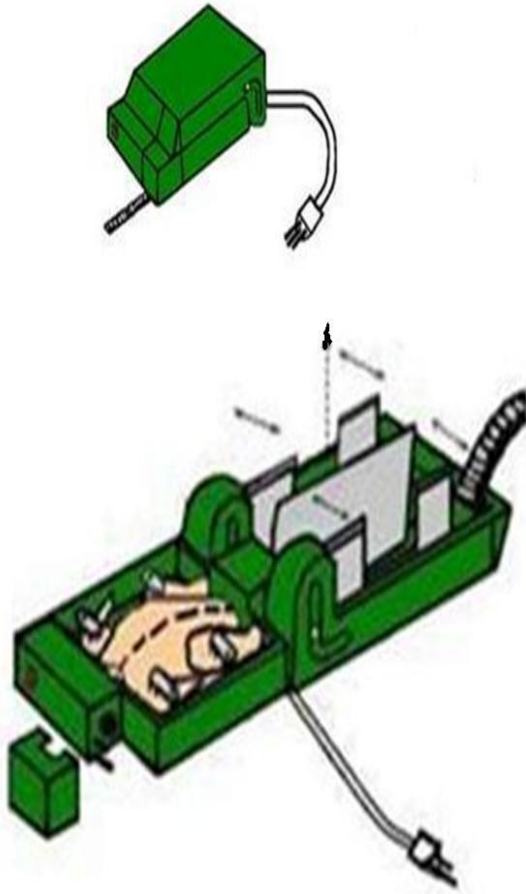

**Model -02 Green**

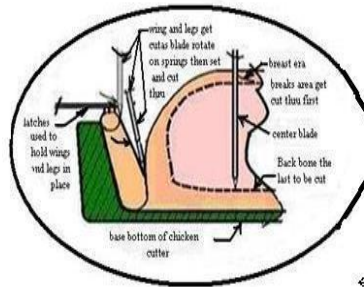

**Enlarge View**  
of the chicken cutter shown how blades work to adjust of bird and to min. motor requirements so this appliance works like a charme never cutting thru more thna one bone at a time

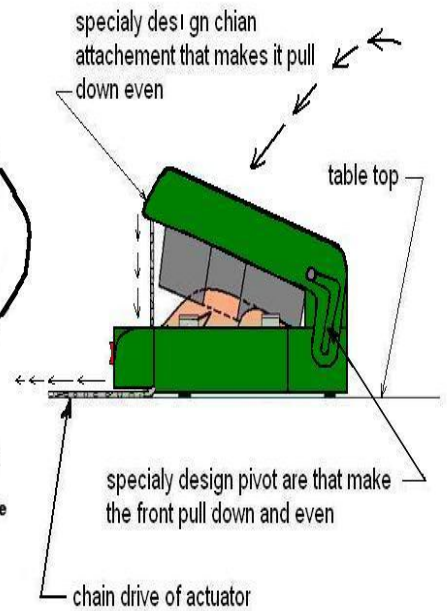

THE HOUSEHOLE CHICKEN CUTTER SCHETCH IT NOT TOO SCALE A PICTURE REPERSENTATION OF THIS APPLIANCE WITH IT AJUSTABLE BLADES TO AJUST TO THE SHAPE OF THE CHICKEN , THIS APPLANCE IT PATANTED TO HAROLD C CHRISTIAN PATENT PENDING

**The Household Chicken Cutter price EUR 125.00 or \$163.75**  
**All engineering and design work it done to create this technology**

**now to order simple send purchase order and deposited proof of payment in the form of a letter of credit in some bank and inform me and my corporate bank what and where the proof of payments it so we can verify it**

**White Model No. 340032-2008-1 EUR 125.00 or \$163.75**

**Black Model No. 340032-2008-2 EUR 125.00 or \$163.75**

**Green Model No. 340032-2008-3 EUR 125.00 or \$163.75**

## **Construction Division**

**The new technology need to make this product available to you was developed by the owner and inventor of this corporation solid construction all metal as strong as a security doors or stringer can be adjusted as if it weren't and air tight sealed all around to save leak and energy**

**All engineering and design work it done to create this technology now to order simple send purchase order and deposited proof of payment in the form of a letter of credit in some bank and inform me and my corporate bank what and where the proof of payments it so we can verify it**

## **Energy Saver Door Patent pending # 8284**

**Save oil, gas and electric energy this product save up to 20% to 30% percent on heating and cooling products manufacture by this company the energy saving floor vents 65% to 75% percent saving on all heating and cooling bills Prices**

**includes a box with a frame and instruction book / no charge for plating And shipping paid on all replacements due to default products or workmanship a door that designed to take Up gaps in a houses or dwelling as it settle over years will never have to be Neither re-shims or resealed, nor Replaces them**

**The sizes adjust to take up least a 1.00 10 Inch gap around l sealing Gaps in doors all-around of about an inch. Never have to be re shim or**



**Sealed, just needs Adjusting with a screw driver, comes in all shapes and Design the adjustable door will saves you loads on your Heating and cooling, repair also maintains bills.**

**Most Doors required this operation at least 2 times a year Winter and summer at about \$30.00 each time for a total of \$60.00 a year and look at all that work time and money, Comes with a life time warranty as long as you own the house You can add a \$25.00 to \$30.00 dollar mark-up to this Product and still this door it below other energy saving Products like water heater, refrigerator stoves which they Have setting in their homes already selling for as much as \$500.00 to \$600.00 dollar**

**Some will have to be replaces when their shelf lives up but this product will save those hundred**

**Saver Screen Door Model No. 340032-2414-1- Alum. Prices EUR 175.00 or \$219.25**

**Model No. 340032-2414-2 FIBER GLASS Prices EUR 175.00 or \$219.25, Steel zinc plated EUR 175.00 or \$219.25, stainless steel EUR 250.00 or \$327.50**

**These product will go thru a endurances test will have to pass a 500 hour continually running test without failure so will all my product conform to this as a minimal standard a continue endurances of weather and flexibility and the endurance all components in all kinds of weather, For Rust and cracks in marterial or degrade of material due to time and weather, all must show none after test or doing test These test and grantee the manufacture of these product over and above all other test**

**These test and grantee are made by the manufacture of these products over and above all other test**

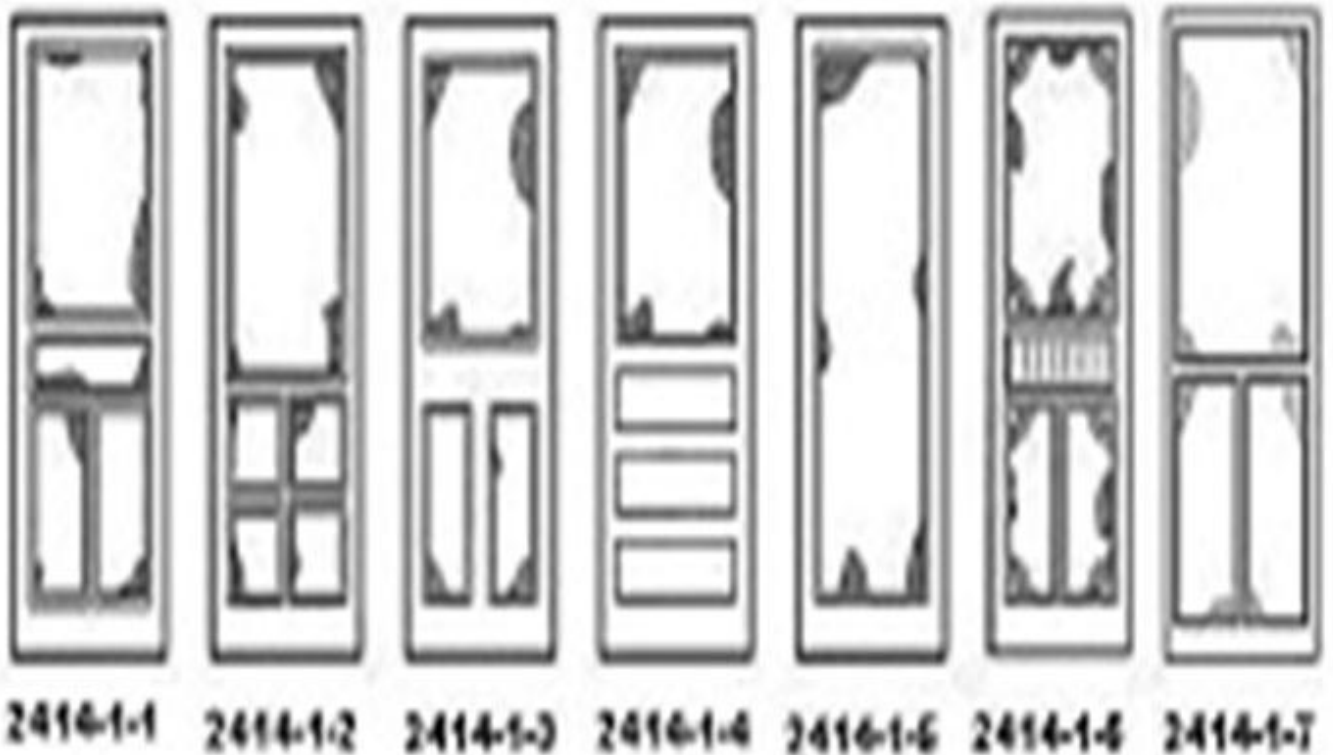

**screen doors and model number are as shown  
 simple select the door style you want send in your  
 purchase order and I/c to my corpate bank and me  
 them frist it pronbaly be easiers for them to contact  
 me then until start uo finished  
 the bellows energy saver doors style avialable  
 listed above self sealing , life time warnty**

**color of your choice or simple zinc plate you paint to sue your self**

**2414-8**



**2414-9    2414-10    2414-11    2414-12**

**entry doors and model number are as shown  
 simple select the door style you want send in your  
 purchase order and l/c to my corpate bank and me  
 them frist it pronbaly be easiers for them to contact  
 me then until start uo finished  
 the bellows energy saver doors style avialable  
 listed above self sealing , life time warnty**

**color of your choice or simple zinc plate you paint to sue your self**

**2414-14**

**All engineering and design work it done to create this technology now to order simple send purchase order and deposited proof of payment in the form of a letter of credit in some bank and inform me and my corporate bank what and where the proof of payments it so we can verify it**



2414-15

Adjustable door/aluminum or stl/ or str/  
stl can be fiber glass comes in a  
screen or regular outer doors in the  
design shown , painted to look like  
wood / with a life time warranty and  
with resealable and adjustable edge  
to tkae up gaps but it as strong as a  
solid door

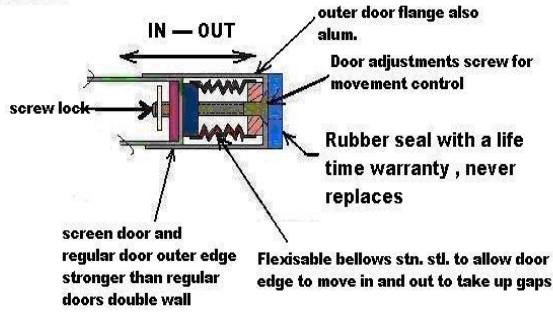
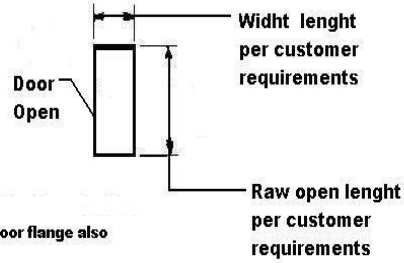

Door comes in all styles or as requested we'll  
make it too sue you

**2414-8**

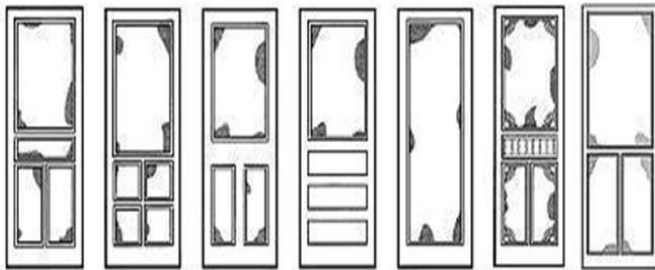

2414-1-1 2414-1-2 2414-1-3 2414-1-4 2414-1-5 2414-1-6 2414-1-7

any of these standard shapes can be order in any of the above materials you  
choices

screen door design avialable plus  
any other per your requested

THE BELLOWS DOOR INNER WORKING

**Comes in a color or style paintable  
alum**



2414-9 2414-10 2414-11 2414-12

Outter metal doors with a imittaketional wood  
finidished in these design and other of your choice



**2414-14**

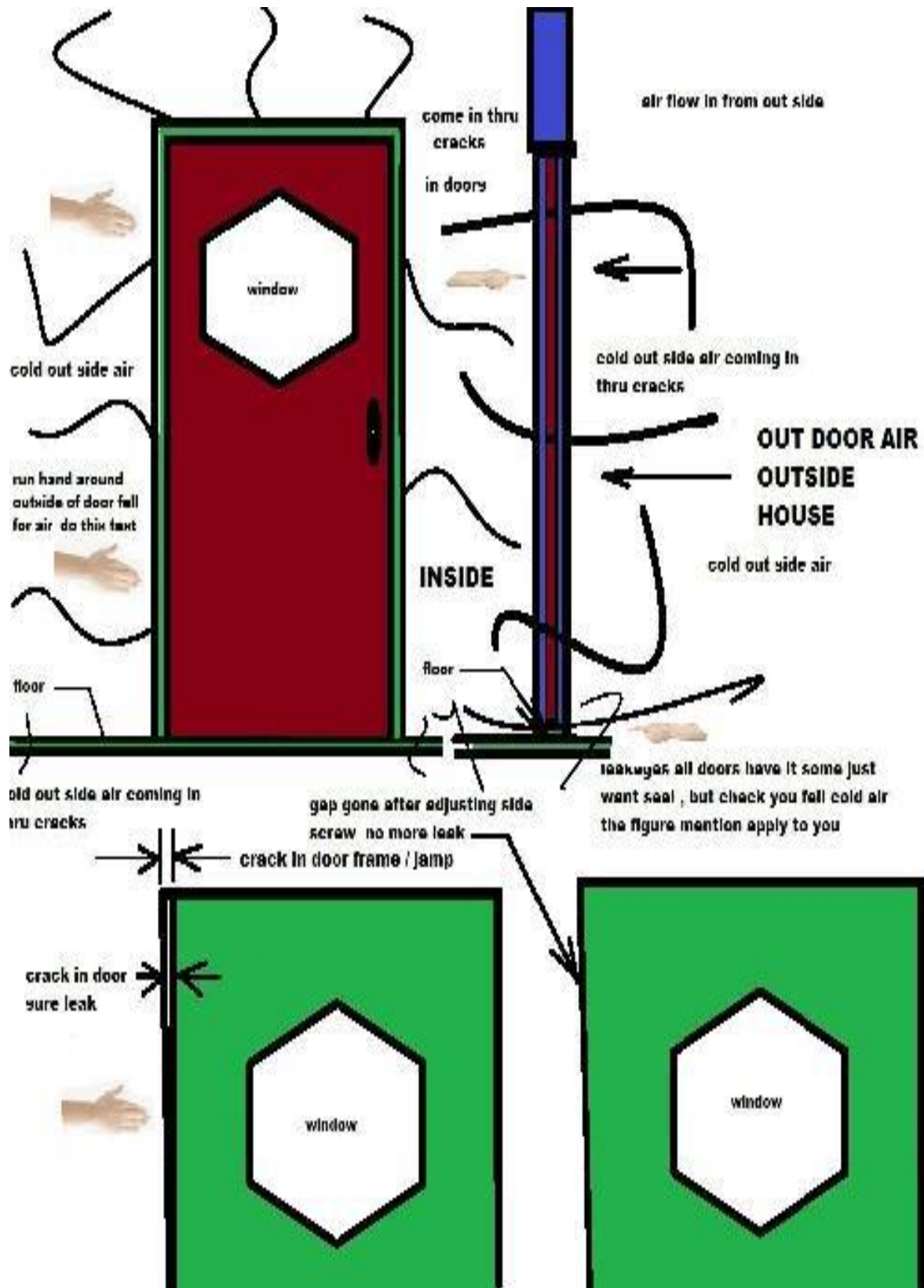

**The Bellows Energy Saver Screen and Outer Doors Prices EUR 175.00  
or \$219.25**

## **HOUSEHOLD DIVISION**

**The new technology need to make this product available to you was developed by the owner and inventor of this corporation,**

**This vent it design and make in a way that makes it unbreakable Never need to be replace like existing plastic vents of this type that are contently have to be replaces because of breakage when step on and are permanent attached to the floor and repaint over and over again coming all sizes not flimsily slip fit with magnets permanent vents**

**All engineering and design work it done to create this technology now to order simple send purchase order and deposited proof of payment in the form of a letter of credit in some bank and inform me and my corporate bank what and where the proof of payments it so we can verify it**

**Energy saver Floor Vent: Patent pending #  
2814,**

**Save oil, gas and electric energy Saves up to 50% percent on heating and cooling bills And when used in conjunction with other products manufacture by this company the energy saving screen doors and outer doors the saving can be as much as 65% to 75% percent's Prices Includes box with hardware for attachment, life time warranty And shipping paid on all replacements due to default products or workmanship A vent that made for climate control that funnel air to the Center of a room away from door / windows patio door / Unbreakable that Allows you to put vents in front of patio door and window That Will not waste air by flow it up in too a cold window Or**

door but funnel the air it to the center of room for Better climate control. You can add a \$10.00 to 20.00 dollar Mark-up to this product also and still not be able to keep It on the shelf For new and old construction, will save you hundreds of Dollars on heating and cooling bill and make any much more Comfortable than normal by getting rid of those cold and Hot spot by selling this for \$19.95 or \$29.95 it will Still mean hundreds of dollar worth of saving for your Customer and with a life time warranty Life time Warranty,

By evenly heating and cooling your house doing Away with those cold and hot pots which causes heating And cooling system to run a lot you will save hundreds of Dollar year around making their live spaces much more comfortable, also Saves Oil and Gas and Electric Energy Saver Standard vent sizes Alum, Plastic, Stainless Steel or Steel Plated, With Zinc or galvanize plate EUR 9.95 x TWL= TC = Total Cost. Best value steel plated unlimited warrantee for rust Resistances and it the same cost as alum and plastic just Not the light weights material but prices the same Stainless Increase only

**Standard Sizes = 2x10", 2x12", 2x14" 3x10", 3x12", 3x14" 4x10", 4x12", 4x14" 6x10", 6x12", 6x14" .also make your request Steel =EUR 9.95, Alum= EUR 9.95, Plastic= EUR 9.95, or \$12.05, Special Stainless Steel Grates = EUR 37.95 or \$51.95**

**Specialty Floor Vent Model No. 340032-814 Prices EUR 9.95, or \$12.05**

**Floor Vent Model No. 340032-814 Prices EUR 9.95, or \$12.05**

These product will go thru a endurances test will have to pass a 500 hour continually running test without failure so will all my product conform to this as a minimal standard. That a continue endurances of weather and flexibility and the endurance all components in all kinds of temperature and flexibility and the endurance in all material in all kinds of temperature, to made sure they done break and hole there



from, These test and grantee are made by the manufacture of these products over and above all other test

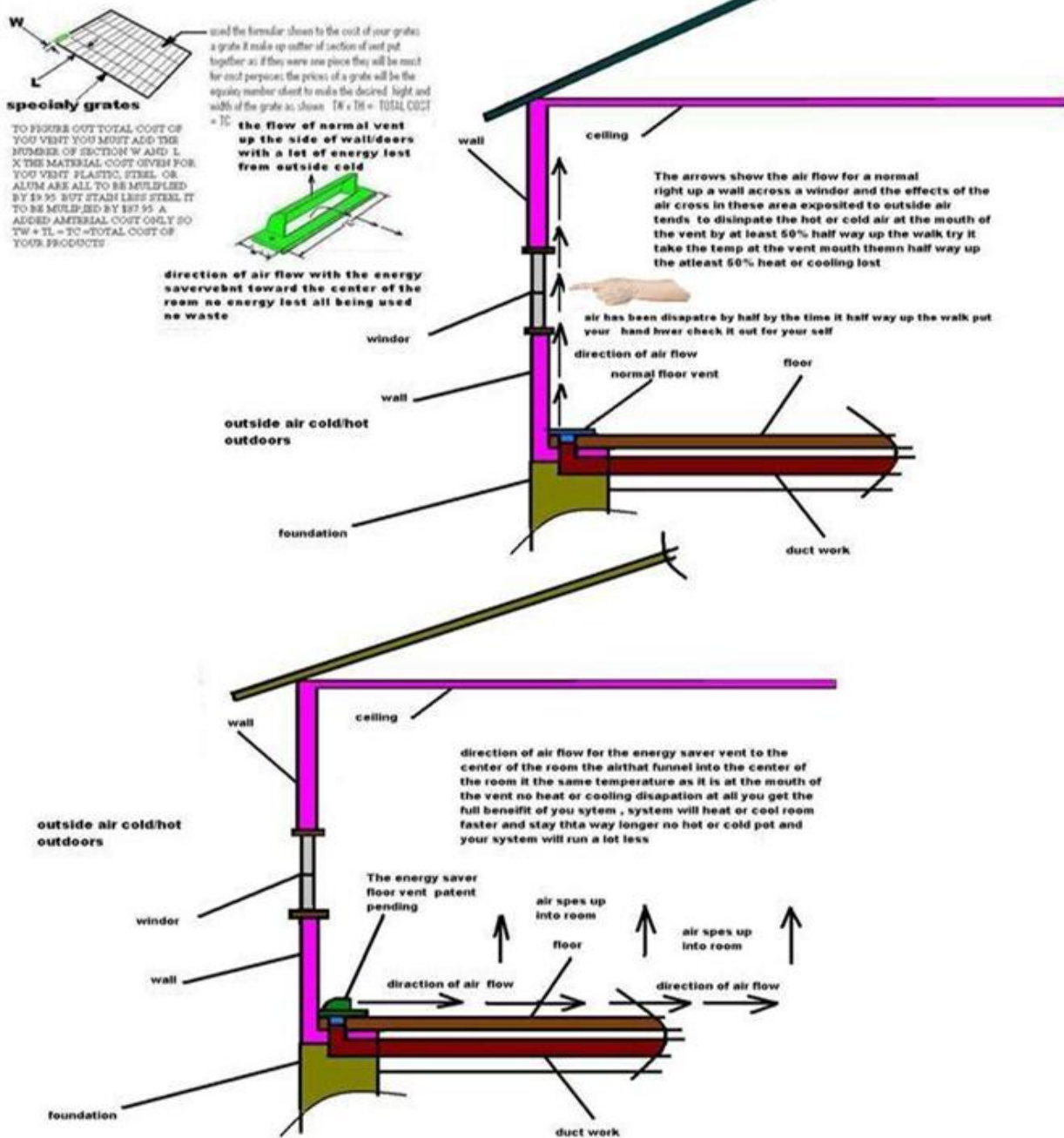

All engineering and design work it done to create this technology now to order simple send purchase order and deposited proof of payment in the form of a letter of credit in some bank and inform me

and my corporate bank what and where the proof of payments it so we can verify it

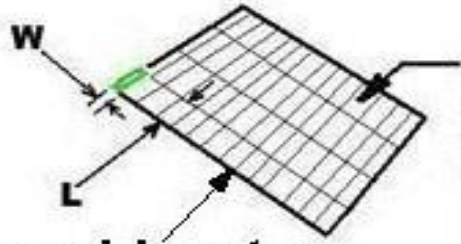

**specialy grates**

TO FIGURE OUT TOTAL COST OF YOU VENT YOU MUST ADD THE NUMBER OF SECTION W AND L X THE MATERIAL COST GIVEN FOR YOU VENT PLASTIC, STEEL OR ALUM ARE ALL TO BE MULIPLIED BY \$9.95 BUT STAIN LESS STEEL IT TO BE MULIPLIED BY \$37.95 A ADDED AMTERIAL COST ONLY SO TW + TL = TC =TOTAL COST OF YOUR PRODUCTS

used the formular shown to the cost of your grates a grate it make up outter of section of vent put together as if they were one piece they will be must for cost perposes the prices of a grate will be the equality number ofvent to make the desired hight and width of the grate as shown  $TW \times TH = \text{TOTAL COST} = TC$

**the flow of normal vent up the side of wall/doors with a lot of energy lost from outside cold**

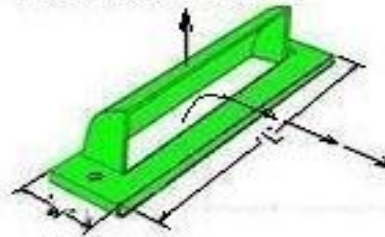

**direction of air flow with the energy saver vent toward the center of the room no energy lost all being used no waste**

2x10",	-01	added -A	added -P	added -ZP	added -SS
2x12",	-02	added -A	added -P	added -ZP	added -SS
2x14"	-03	added -A	added -P	added -ZP	added -SS
2x10",	-04	added -A	added -P	added -ZP	added -SS
3x12",	-05	added -A	added -P	added -ZP	added -SS
3x14"	-06	added -A	added -P	added -ZP	added -SS
4x10",	-07	added -A	added -P	added -ZP	added -SS
4x12"	-08	added -A	added -P	added -ZP	added -SS
, 4x14"	-09	added -A	added -P	added -ZP	added -SS
6x10"	-010	added -A	added -P	added -ZP	added -SS
6x12",	-011	added -A	added -P	added -ZP	added -SS
6x14"	-012	added -A	added -P	added -ZP	added -SS
Stn. Stl. Grates =	EUR 37.95	added -A	added -P	added -ZP	added -SS

# TOOL DIVISION

## **Dry Wall Restorer and Hole Patch: Patent Pending # 1662,**

**Comes with a tool that allows you to reach behind and inside walls to create an inner and outer skin actually reconstruct the wall as if there was never a hold The new technology need to make this product available to you was developed by the owner and inventor of this corporation,**

**All engineering and design work it done to create this technology now to order simple send purchase order and deposited proof of payment in the form of a letter of credit in some bank and inform me and my corporate bank what and where the proof of payments it so we can verify it**

**Dry Wall Restorer and Patch: Model No.  
340032-1662 Prices per Kit: EUR 24.99  
/49.99 or \$39.25 / \$64.44**

**Prices includes mash for outer and inner wall, instruction book, outer and inner cover, Plaster or wall filler material in plastic container, an Inner and outer plastics installation tool that reused able, all come in a boxes as a package with a life time warrantee on all repairs, idea for rental apartment and homes were you exchange renter and those holes that are all ways their well you know they not the owner so they Not as carefully but excellent for home owners also if for any reason the filler falls out we replaces the whole kit. If for any reason the filler falls out we replaces the whole kit and shipping paid on all replacements due to default products or workmanship A wall restorer**

**that will fix holes in dry Wall up to the Width of a joist and ½ the size of a sheet plasters board. Will completely Restores a wall like new, not just a Patch, it in visit able to the eye, will match any Surfaces and painting arrangements comes with wall compound And brazes and all brazes are removable and reused able, Can be easy to use by Home owner or professional you Can add a mark-up of \$10.00 to \$20.00 to this product, And sell it for 39.00 or 59.00 even \$79.00 not even cost them what a carpenter or the cost of a good Sheet of Plaster board plus the work to installed it and for this Prices, the total job done they never I have to be replaces The fix like patches always fall out Dry Wall Restorer and Hole Patch Model No. 340032-1662-01/-02: Prices per Kit: EUR 24.99-01 /49.99-02**

**Them what a carpenter or the cost of a good sheet of Plaster board plus the work to installed it and for this Prices, the total job done they Never I have to be replaces the fix like Patches always fall out Dry Wall Restorer and Hole Patch: Model No. 340032-1662: Prices per Kit: EUR 24.99-01 /49.99-02 or \$39.25-01 or \$64.44-02**

**These product will be thru a endurances test will have to pass a 500 hour continually running test without failure so will all my product conform to this as a minimal standard. That a continue endurances test in all kinds of weather and breakability and the endurance for this product will be thru all kinds of weather all material used must not degrade because of temperature of weather must stay intact and not be remove bale even doing or after endurances test, but all Ahearn's to walls but be intact and solid after test These test and grantee are made by the manufacture of these products over and above all other test**

**All engineering and design work it done to create this technology now to order simple send purchase order and deposited proof of payment in the form of a letter of credit in some bank and inform me and my corporate bank what and where the proof of payments it so**

**we can verify it**

**1"-8" hole -01 order -01 EUR**

**29.95**

**7"-24" hole -02 order -02**

**EUR 49.95**

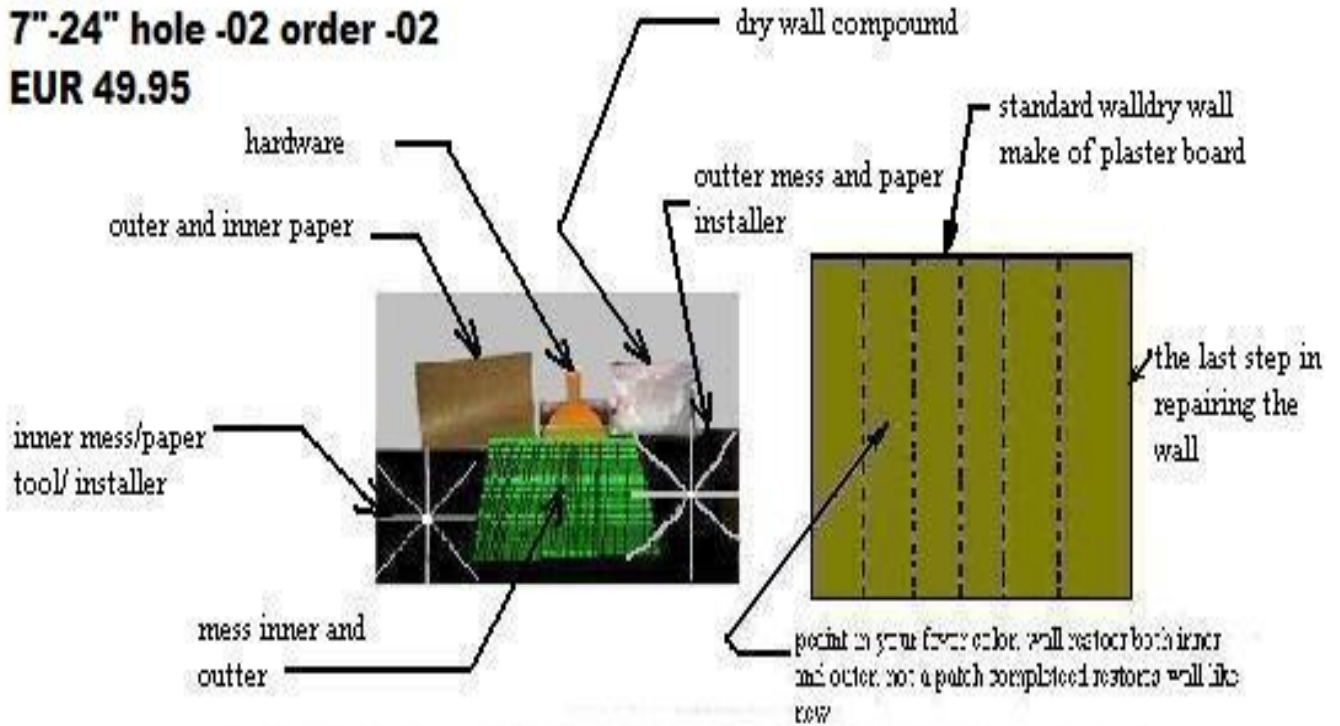

**Dry wall restorer completely restores wall like new not a patch , all that you need to do this job it included.**

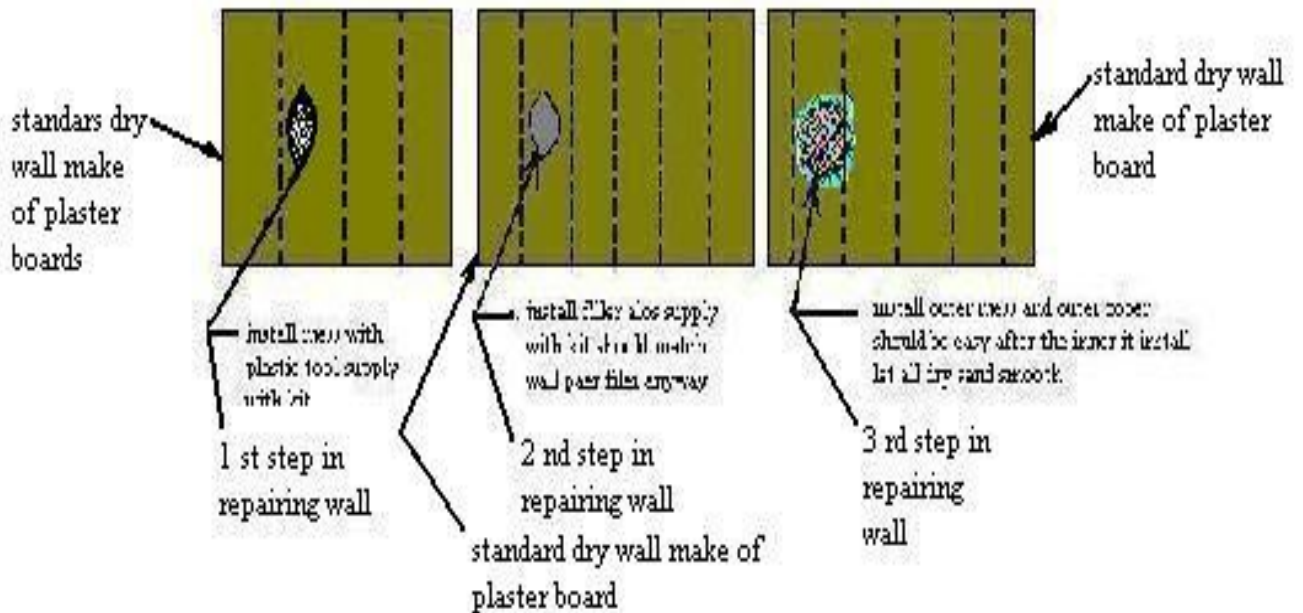

## **AUTO and TOOLING DIVISION**

### **Hand Saver Socket Wrench Set: Patent pending #1646**

**The key this product is the extension they are able to transmitted power over a long extended length in a manner that it does not dissipate nor is there a loss of strength so you can reach behind under and up into even around, they can be used in conjunction with one another so there in so such think as a bolt or screw you cannot easily reach with out keeping your hands completely out of the working area in safety**

**The new technology needed to make this product available to you was developed by the owner and inventor of this corporation**

**All engineering and design work is done to create this technology now to order simply send purchase order and deposited proof of payment in the form of a letter of credit in some bank and inform me and my corporate bank what and where the proof of payments is so we can verify it**

**Model No. 340032-5826-1: Prices EUR 135.00 or \$176.85**

**Prices includes tool box plus Instruction book 256 Piece tool set plus extensions Socket and drives set of all types, plus the extension That allows you to work hand free, And shipping paid on all replacements due to default products Or workmanship A wrench set to reach around and behind into hard to get Too places / low Profile can be used with air/electric or Manual drive, come in different length and with a completed Set of adapter and Drives form Quarter to Half the hand saver Wrench system, will save your hands and time and money on All kind of repair, as we know in repair work time it Money. This wrench will keep your hand up and away from all the work, your hand are not turning anything or doing Any work the wrenches do it all this is a set of 256 pieces.**

**You could marker this product up \$25.00 to \$30.00 Dollar and still be below the standard prices for Industrial grade professional tools, tools which some sell For over a \$1000.00 at \$165.00 or even \$175.00 Send technical spend thousands of dollars for tools Like this \$5.00 one it unheard of \$25.00 /30.00 usual only The manufacture makes that kind of money with me you can too.**

**Hand Saver Socket Wrench Set: Model No. 340032-5826-1:  
Prices EUR 135.00 or \$176.85**

**These product thru a endurances test will have to pass a 500 hour continually running test without failure so will all my product conform to this as a minimal standard. That a continue endurances test in all kinds of weather and**

**breakability and the endurance all components in all kinds of situation including strength of material as such as they want break in any situation or rust due to weather or usages and the endurance includes all material used to made this set of wrenches and drives. These test and grantee are made by the manufacture of these products over and above all other test**

**The Hands Saver Socket Wrench Set: prices: EUR 135.00 or \$176.85**

**All engineering and design work it done to create this technology  
now to order simple send purchase order and deposited proof of payment in the form of a letter of credit in some bank and inform me and my corporate bank what and where the proof of payments it so we can verify it**



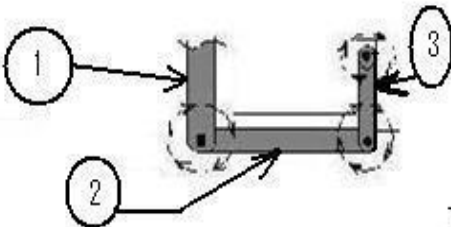
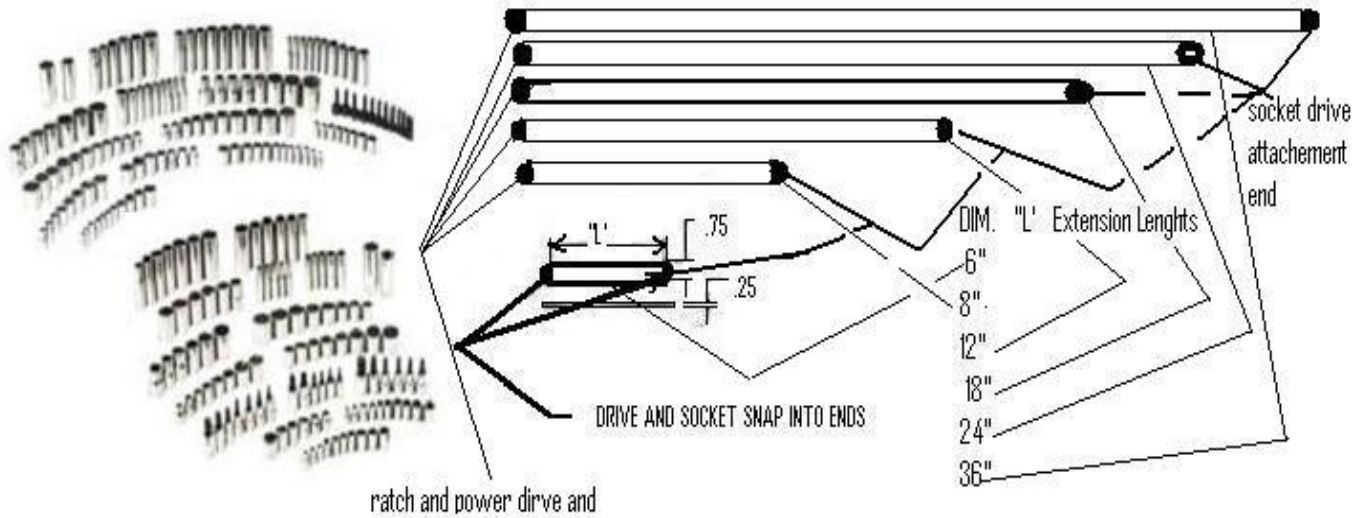

this it a combination of three of these extension put together to reach around and up into or event behinded somethink

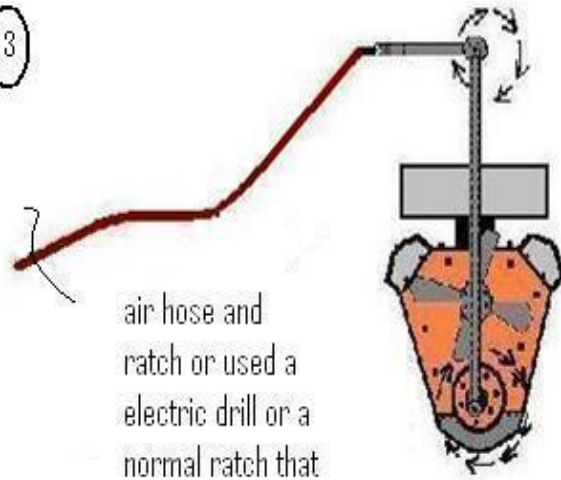

air hose and ratchet or used a electric drill or a normal ratchet that up to you

extension reaching down to the crank shaft cover to loosen a screw with your ahnds completed out of the and away from the work

the break down of the assortment of socket

- Miniature 1/8 drives increments 1/32" to 1/2" = 16 long socket and 16 short sockets = 32
- 1/4 drives incumbents 1/32" to 5/8" = 20 long socket and 20 short at the same incumbent = 40
- 3/8 drive incurrent 1/32" to 7/8" = 28 long and 28 short socket = 56 total
- 1/2 drive increments 1/16" to 1 1/4" 20 long and 20 short sockets = 40 total
- Torx's socket increments 1/32" to 1/2" = 16
- Phillip socket increments miniature, small, medium, and large = 4
- Hex's 1/32 increments 1/32" to 1" = 32
- Square socket increments 1/31" to 1" = 32

All stainless steel polished or unpolished quote both

Total number of pieces per set it 256

# PUBLISHING DIVISION

**The new imaginary genius used to write this book test field of the imaginary genius that was needed to do this invention same skill just used differently. I done this book because at the time I need to be able to earn money form some other source them my engineering skill, but in the process of doing this this inspirational poetry book got wrote of which according to my family ancestor was per ordained this book got so those who kept me from earn money for the true profession engineering actually help for fill these property of helping to inspire people to the gospel of Christ by force in me too try to make money with some means other than engineering that actually got this book wrote or god dii I must said after test in the a water with many critical and contest I found it was very sellable so here it is available from you too enjoyed Poems**

**All these poems are wrote already book ready to be printed, printer contracted to print the books and all the design work for the book and picture withal poems done it all create all ready.**

**This poetry book base on the Christian gospel of Jesus Christ and the old and New Testament of the king James originals translation of the Christian, the traditional baptism faith**

**now to order simple send purchase order and deposited proof of payment in the form of a letter of credit in some bank and inform me and my corporate bank what and where the proof of payments it so we can verify it**

## **Poems of the Light (Wake up you Dead Christ the Light of World)**

**Model No. 340032-2508-1 Prices EUR 45.00 or \$67.95**

**50 poem poetry books which consist of a special prayer/a Short History of the author / a synopsis of the book, this author who wrote the poem hope which was selected for the book? A treasure American poets (poetry soup) a book of the best Poetry writer in America but was not in that but prefer to Put it in my own, but have been published on internet and other many poems a publish writer decide to write his own Book. Prices includes book, box in a decorate boxes and a small displace Stand plastic to show your book, Books are grantee for material and workmanship For returns and shipping paid on all replacements due to default products or workmanship This is a sample poem I grantee they all this good, you want be able to wait to turn the pages to see the next one**

### **Dads and Fathers**

**Dads are always looking to bragging about you  
And glorified in your Father are always looking to bragging  
About you and glorified in you also  
Dad's always pushing you to be your best and  
Assume in you're the best at everything also  
Father are always pushing you to do your best and  
Assume in you're the best at everything also**

**A dad's love it never ending nor will his attempts  
 To get you thru. All things  
 A father love it never ending nor will his attempts  
 To get you thru. All things also  
 The amazing things it your dad's here on earth  
 And your father it he who it in haven  
 Surely they seem to think a lot alike  
 When it concerns you**

**Don't they Dads and Father's**

**This poetry book will inspire you to pick up a bible and Read it check  
 out the of gospel Christian, it also takes Today subject matter, not the  
 same old title said a Different way, each of these poem has multiple  
 means and Scripture references that applied, they not given you must  
 Find them, this book it fun to read and you will never Remember  
 having so much fun with a poetry book while Learning and see god in  
 work your own life also**

**-----Original Message----- To: hcc789456 <hcc789456@hotmail.com**

**Sent: Wed, Dec 15, 2010 4:43 pm we review books. Once the work is in  
 book form we will be happy to review it for you. Shirley Roe Managing  
 Editor all books Reviews [www.allbookreviews.com](http://www.allbookreviews.com) the review after  
 they through I was going to be fooled into  
 paying someone to published this book and I quote good author do not  
 paid to publishes their book they publishes for free and refer me to two  
 publishing company Harold: All books Reviews is not a publisher, but  
 here is some advice. Be very careful of so called poetry contests that  
 announce you as the winner and then want to charge you \$50-\$100 to  
 buy the book where your work will appear on one page. Do not be  
 fooled into thinking that a publisher will spend \$32,000 on your book or  
 anyone else's. If you want your poems published, go to [www.lulu.com](http://www.lulu.com)  
 and publish it for free you can also try [www.publishamerica.com](http://www.publishamerica.com)**

where they will publish it for you for free. Good authors do not have to pay to be published in this any and age Shirley Roe Managing Editor All books Reviews [www.allbookReviews.com](http://www.allbookReviews.com)

poetrycontests12

Sorry sir

I'm not doing individual poems anymore I'll be publishing a book very soon of 50 Poems I be sure to let you know when that it available for purchases

As you know sense I'm writing a book with these poems they cannot win a contest

But thanks anyway

Thanks

Harold C Christian

From: poetry contests

To: [hcc1949va75@hotmail.com](mailto:hcc1949va75@hotmail.com)

Subject: Poetry Soup: A Comment from Poetry Contest

Date: Sun, 9 Sep 2007 12:54:48 -0700> Hi I think your poems are great and I would like to challenge you to a poetry contest

I already joined and I would be honored to have a competitor like you also should know there is a \$100,000 prize. Click here to enter the contest [http://tinyurl /3anw99](http://tinyurl.com/3anw99). To turn this feature off, go to the Poetry Soup Members Area and update your personal information.

[http://www.poetrysoup /poetry\\_update\\_account.asp](http://www.poetrysoup.com/poetry_update_account.asp) Poetry Soup the FREE International Poetry Community [http://www.poetry soup](http://www.poetrysoup.com)

I grantee this book and all the material it make with for wear and fading, for the life of the original owner, this book to meant as a keep sake to be hand down as a gift to love ones so it will be replace at no cost for any material failure if you're the original buyers, that a failure it

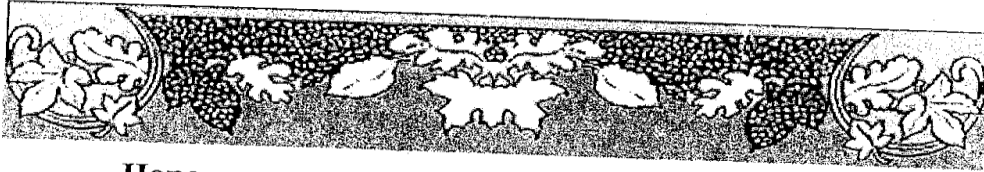

## Hope

One drudge thru day after day  
 Thought pressed on all sides  
 By common and uncommon trails and tribulations  
 Oppression of many diversity and different things  
 Follow in the content of their hearts  
 Being driven by that inner sprit  
 That yearning for the completion and the far fill meant  
 Of the content of the heart  
 Which comes with completion of all  
 Like a carrot golden and ripe  
 That caused you to presses on  
 And insure that you done fail  
 Surely, you press on  
 Hope in for things wished for  
 And things promises  
 Promises make thru the holy sprit  
 Promises that never disappoint.  
 Hope

*Harold Cornelius Christian*

Copyright ©2006 Harold Cornelius Christian



ORDER BOOK



LOGIN TO RECORD YOUR POEM



LOGIN TO EDIT YOUR POEM



YOUR WORDS ON PERSONALIZED PRODUCTS



TELL A FRIEND ABOUT THIS PAGE!

**POETRY CARDS**  
SEND A FREE GREETING CARD

DO THIS POEM AS  
**Poetry in Motion**







-04



the page in both books

I want this writing on this page over  
 the picture in black,  
 but you should get the  
 writing

I want this writing on this page over  
 the picture in black,  
 but you should get the  
 writing



-01



printed page but / picture be faded



-03

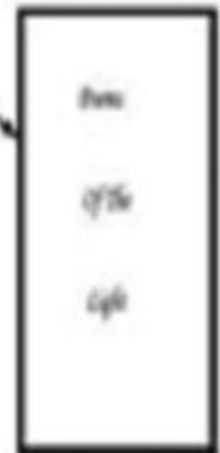

-02

**Book cover and a sample pages**  
**your choice or cover and lanuage \$45.00**

**For book cover you desire used dash number as shown**



**Poems of the Light (Wake up you Dead Christ the Light of World) Poems of the Light: Price EUR 45.00 OR \$67.95**

**And I think god and you for the opportunity to do this here and serve you**

## **HCC (Specialty Products) Limited Liability Corporation**

**Temporally home page form a free import web page do not used for contact proposes**

**Corporate Web Page: <http://www.blazelead.com/Hcc-LLC/>**

**Send letter information for company listed and for and too corporate bank below**

**as we know or i told you the store cannot lose their, money it only be in held by a bank so they can nor welch on the loan and thru want turn it over to me until their product get their or the certification of that area and as advertise right at the quaintly order, now the only person that can lose it me by not getting that order their it up to my corporate bank to work with me in the doing of that as in loans if which they be paid when the money turn over after the order get too the buyer we dine have to worry about payment because the money setting in a bank somewhere already collect , 30**

**% then going pulls some kind deal, too get the rest, then we spend all that time and money to get you some think your deal and fell thru you got nothing too pay, out of money so it the bank of china, but with the letter of credit system which all company insisted on that impossible. No welch and frail manufacture impossible**

**And the only one can lose it the inventor or manufacture by not getting the work, then it be between the bank of china they would probably start making recommendation to fix whatever the problem to get the work done regardless you works get done if the buyers get his money back, that the supervise the building of these product all other work done , i be doing that myself all thru set up then when every set running smooth in turn every think over to manufacturing engineer and my staff o I start on next years release and were up and operation like all other company daily**

**HCC (Specialty Products) Limited Liability Corporation, Finials officers and President: Mr. Harold C Christian Second : Control ( to be Name Later ) and Vice President of Operations ( to be name later) these are the only people in this company that will be authorized to handle letters of credit and payments or handle corporate money**

### **SET UP LETTER OF CREDIT OR NOTIFEID**

**Industrial and Commercial Bank of China Limited  
55 FuXing Men Nei St., Xicheng  
District Beijing 100140, China  
Tel. +86-10-6610-8608  
Fax +86-10-6610-6139**

**Letter of credit should be for**

**Thank Harold C Christian**

**Owner and President /Inventor of HCC (Specialty Products) Limited Liability Corporation I.D (340-032-2) Temp address below for startup paper work to get registration so I could get a tax's**

**To contact by mail other used e-mail address on catalog**

**E-mail: [hccfairwoodlane@aol.com](mailto:hccfairwoodlane@aol.com)**

**1053 Fairwood Lane Olathe, Kansas, 66061**

**Below it a sample of what the bank of china will required for it letter of credit**

**Thank**

**Harold C Christian**

**Owner and President /Inventor/ Designer**

**Of**

**Thank Harold C Christian**

**Owner and President /Inventor of HCC (Specialty Products) Limited Liability Corporation I.D (340-032-2) Temp address below for startup paper work to get registration so I could get a tax's**

**To contact by mail other used e-mail address on catalog**

**E-mail: [hccspecialtyproductllc@aol.com](mailto:hccspecialtyproductllc@aol.com)**

**1053 Fairwood Lane Olathe, Kansas, 66061**

**Phone 1-434-846-7230 As for the phone number here it a family member who can get in touch with his sister who can get in touch with me if necessary he has nothing to do with this company but I told you have a letter of credit or some of that magnitude to send me he tell her she get in touch with me, I you**

**Below the registration of this company the original paper work done tin Olathe Kansas**

**Too get taxes I.D (340-032-2) so I could start the sale of this product below**

**The new technology need to make this product available to you was developed by the owner and inventor of this corporation**

**All the position listed on that legend is open for resume except the two top (President and Vice President Operation) position all other are**



**HCC (Specialty Products) LLC**

**LEGEND**

**HCC (Specialty Products) Limited Liability Corporation  
CORPORATE STRUCTURE**

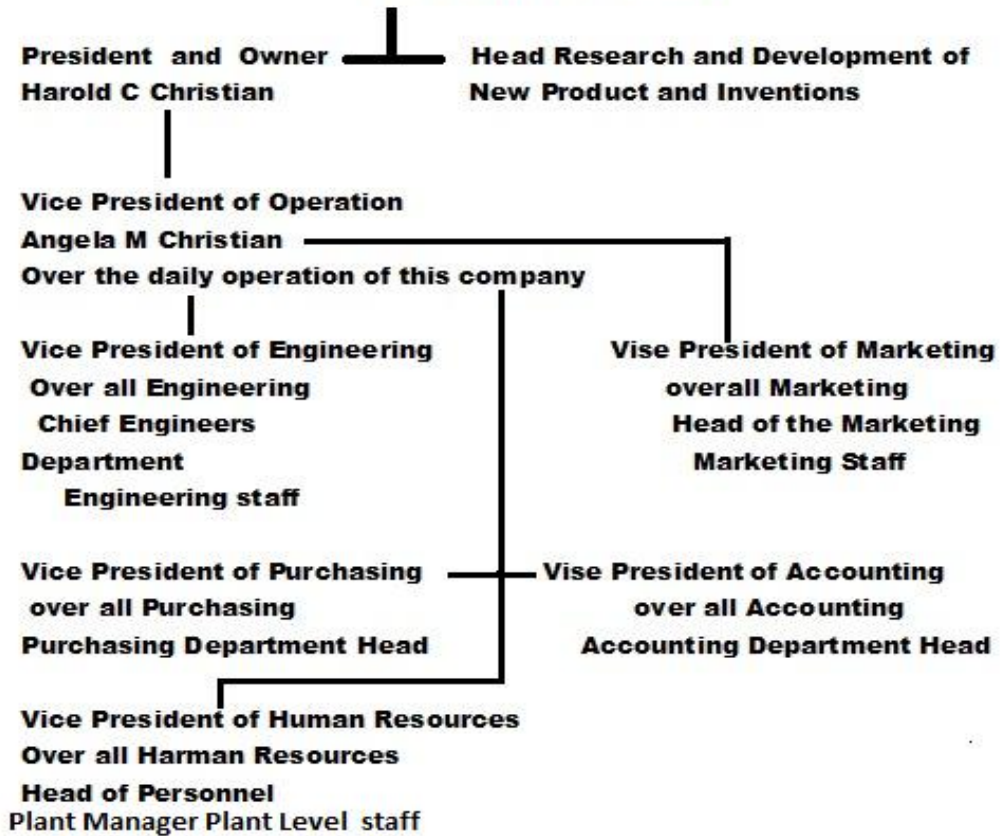

**RON THORNBURGH**  
Secretary of State



**STATE OF KANSAS**

Memorial Hall  
120 S.W. 10th  
Topeka, KS 666  
(785) 2

July 06, 2008

**HAROLD C. CHRISTIAN**  
RE: **MCC SPECIALTY PRODUCTS, LLC**

**MCC SPECIALTY PRODUCTS, LLC**

ID #: 340-030-2

Dear business customer:

Our records show that your business entity has been forfeited as of 7/13/2008 for failure to timely file the 12/2007 annual report and fee. If you wish to reinstate, you may download the forms by visiting our Web site at [www.kssos.org](http://www.kssos.org).

Please return all documents and fees together in one envelope.

all feed feeds have been paid, and this corporation it on a graces period because it going thru start-up and will be under this graces period until operating cash and it thru the start-up process has order and it full operational then normal feeds will continue

This corporation was registrate in the state of kansas but it control and regurlate by the commerce department of the united state od america , it is a llc , a private company , one owner and inventor of these products, founded to employee hire employee to sell and market his creations

Business Services (785) 296-6344  
FAX (785) 296-6370

Web site: [www.kssos.org](http://www.kssos.org)  
e-mail: [business@kssos.org](mailto:business@kssos.org)

Electronic (785) 296-6344  
FAX (785) 296-6370

JOHN V. NITCHER  
MICHAEL E. RILING  
LOUI L. GABBER  
STEPHEN GARLOW  
PERRY L. FRANKLIN  
BOY T. ARTMAN  
CURIS M. WISELER  
STEVEN J. HILBERT  
BRYN M. KENNEDY

**RILING, BURKHEAD & NITCHER**  
Chartered

Established 1900  
308 Massachusetts Street  
Post Office Box 9  
Lawrence, Kansas 66044-6196  
785-841-4700  
Fax 785-841-0191  
Web Site [Rilinglew.com](http://Rilinglew.com)

EDWARD Z.  
JOHN F. HILL  
GEORGE K. F.  
JAMES L. JOE  
EUGENE C. A.  
M. DEAN BURK  
MICHAEL F. DE  
OF COUNSEL  
\*Also Admitted in IA

Harold C. Christian  
1053 W. Fairwood Ln.  
Olathe, KS 66051-2413

April 22, 2003

Re: Our File No. 48560

Dear Mr. Christian:

I reviewed the patent information you sent me, which included the following patents issued to Harold Christian:

- #1890, issued 8/14/2001, for a *air filter*
- #2814, issued 12/27/2002, for a *door vent*
- #1646, issued 12/27/2002, for a *wrench*
- #2814, issued 12/26/2002, for a *dry wall patch*
- #2814, issued 5/23/2002, for a *screen door*

Provisional patent #1890 has expired, as of 8/14/2002. You also sent me a notice regarding non-provisional patent application, dated 9/10/2002, which appears to have been filed too late to extend the filing date for #1890. For the remaining provisional patents, you must file a corresponding non-provisional application, during the 12-month pendency period of the provisional application in order to benefit from the earlier filing of the provisional application. I have included information from the USPTO website regarding the process for Provisional Application for Patents.

You have asked for advice, in your fax cover sheet, stating you want me to supply information necessary to keep the patents activated or to finish the process if necessary. In order to keep your patents activated and to finish the process, you must file non-provisional patent applications for each of the provisional patents stated above, during the applicable 12 month pendency period. I have also included information from the USPTO titled "A Guide for Filing a Provisional (Utility) Patent Application." In that guide, the USPTO states: "A patent application is a complex legal document, best prepared by one trained to prepare such documents. After reviewing this guide, you may wish to consult with a registered patent attorney or agent."

My recommendation is the same. We would be happy to make a referral for you to a patent attorney in Kansas City, if you call or write me making the request for a referral. As a member of

COPY

a list of my patent as you can see the number match the number on these add so do the name they were all done by me and the patent also wrote by me to start this corporation so i could recieve the produce of my professional will hire staff and employee too maunufacture and sell these and other

## **Main Customers**

**Retail stores, hardware stores, super markets, discount stores, and Whole sales store of any kind do not sell to general public nor can this company spam any one sell too business customer only**

**This is a manufacturing company I sell products to anyone who will buy them min. normal order it 1000, but that a small normal order are usual larger,**

## **THIS IT THE NORMAL FOR START –UP**

**the products being made in the country of China the household appliance all models, and the book being printed their the energy saver vent it being toll and modeled there, also the socket for the wrench set being modeled there, as you can see the vendor are from their making most of the components for startup I can get your their name if need all set up and bid in and selected start will be easy really and the tool for the dry wall restore and patch made their also, I've also component manufacture of the mess and paper line up for the dry wall patch and restore form all over including Viet Nam and other obviously if all order flow into the bank there will be multi plus vendor for all those think many have limited that we required more than they can made as to multi-vendor for all this stuck startup will be easy just mostly assembly at my home pant except for the doors and the extension for the wrench set will be total manufacture at my corporate headquarters and start ship plant were every that be it will be decide after start letter of credit are in the bank of which I will be using the**

**bank of china for my corporate bank of which I know I other company can used that or any other bank on the plant that legist I leave the legist think up too you them the bankers, do not contact me put your order and letter of credit in the any of you choice contact my bank they will be collecting the money if you bank if suitable to them it suitable to me, let them contact me , with an ax copy of the letter of credit to sign we start the process this until start over then if you prefer when regular communication are set up contact me but you will be dealing with my corporate bank anyway too get this process started , done this many time working for the company here command place to do it this way**

**What the hold waiting on you buy these product especially the one who send inquired asking permission to buy these product and it been given but just disappear with no expert nation at all**

**Simple send your order to and proof of pay to my corporate bank listed in my catalog they will fax a copy to my location where I meet with a banking official sign the letter of credit paper work then your get your product a fax copy remember it as good as a hard copy anywhere, then I goes the bank I the information concern in vendor and my hole plan to get these too you and we get started on the work as you can see with the vendor already pick and with the little fabrication I be doing in this startup of my own employee that the suck that old not being done in another location but completed fabricated at my plant that not of the shelve or simple haven to stay on top of a vendor to make sure they get the component they building right start will be very easy and you probably seethes hitting you dock in about 45 days but too be safe I allow or telling everyone 75 days HCC (Specialty Products) Limited Liability Corporation, Finials officers**

**President: Mr. Harold C Christian**

**Second: Control (to be Name Later) Third: Vise President of Operations (to be name later)**



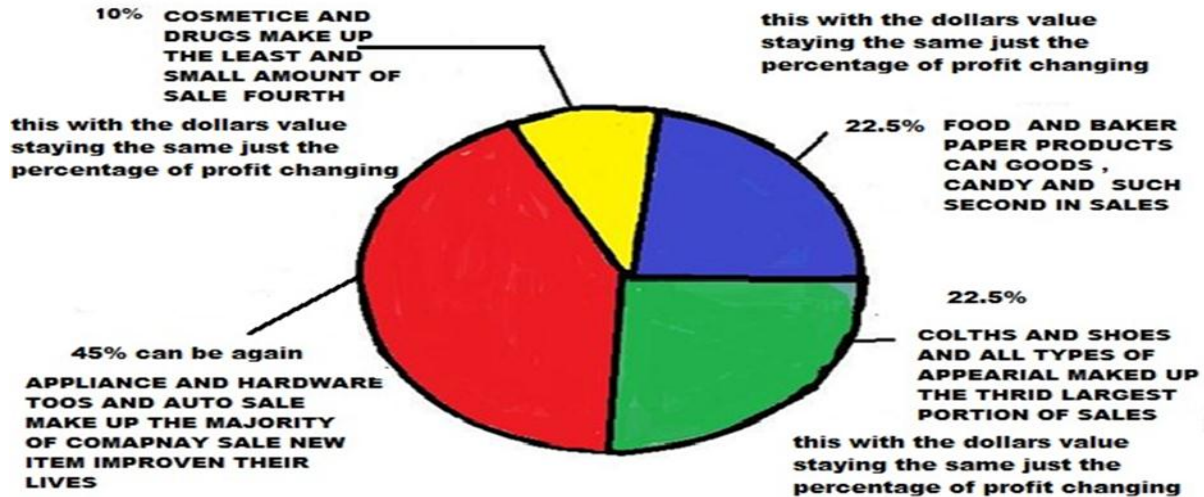

How your charts look check your chart go back 30 or 40 year , how much of your profit were from small household appliance , hardware , auto tools and such , how much now from cthose veris colths and food products , want to change the

Now surpouse with the induction of food and cloths and make up right just surpouse same those department had much nmovement as then they still can get your order and watch those types of figures retrun and profit go up accordingly

How you get these profit and percentage back? a company head by a great inventor that can supply the types of new products you had then like my self supply in the types of products you had bach then

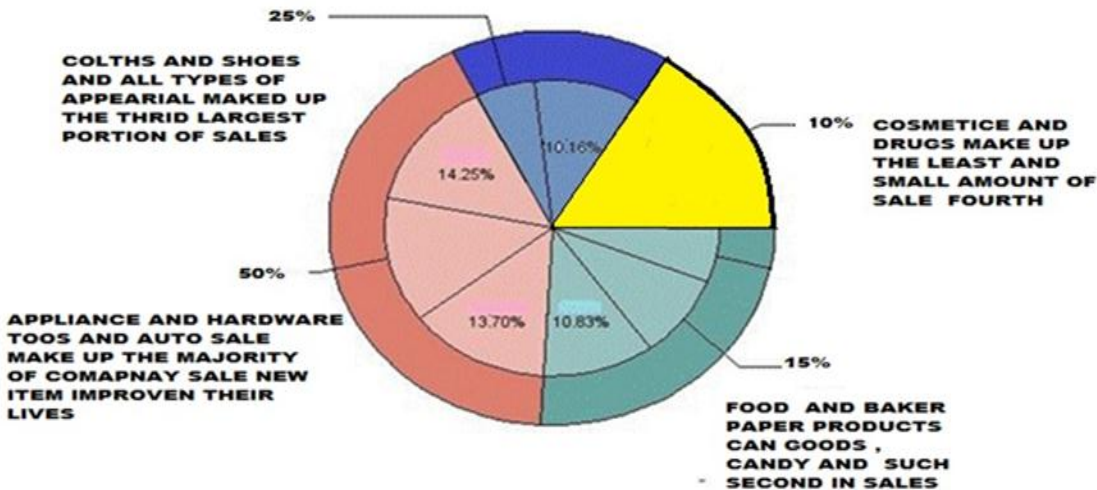

How your charts look check your chart go back 30 or 40 year , how much of your profit were from small household appliance , hardware , auto tools and such , how much now from cthose veris colths and food products , want to change the

Now surpouse with the induction of food and cloths and make up right just surpouse same those department had much nmovement as then they still can get your order and watch those types of figures retrun and profit go up accordingly

**Contact me or the bank of china to set up  
your letter of credit used e-mail below**

**E-mail: [hccspecialtyproductllc@aol.com](mailto:hccspecialtyproductllc@aol.com) or**

**[hccspecialtyproductsllc@live.com](mailto:hccspecialtyproductsllc@live.com) and**

**[hccspecialtyproductsllc@yahoo.com](mailto:hccspecialtyproductsllc@yahoo.com)**



**Signature:**



**HCC (Specialty Products) LLC**

LOGO