



GOODNITE



GOODNITE SDN BHD

Content

Company Background	05
Vision & Missions	06
Winning Factors Of Goodnite	07
Networking	08 - 09
Expo Exhibition	10 - 15
Successful Project	16
Brand Philosophy / Positioning / Promise	17
Achievement	18
Coil System Technology	19
Coconut Fibre / Natural Latex / Memory Foam	20
Ticking Innovations	21 - 22
Product Series	23 - 54
Bedding Accessories	55 - 59
Mattress Tips	60 - 62

Company **Background**

Goodnite resounds with quality comfort and superior sleeping assurance since 1989 and without looking back: we've expanded ourselves into a leading bedding manufacturer in the domestic and international scene.

Goodnite believes a quality sleep equates to a healthy living and we support that, iterally, with the industry's finest technology alongside our commitment, quality and service, to deliver that promise. With a dynamic team, from our management down to our research team, we are constantly looking forth to innovate and enchance the definition of premier quality bedding.

Our commitment stems from our experience to provide you uncompromised quality standards and that makes our growth promising to serve you for generations.

In fact, Goodnite's already the trusted name throughout generations. With our expansion to the north and south region of Malaysia, our team of more than 150 employees services more than 1,200 dealers nationwide to provide you superior comfort.

We keep reaching out because we believe that everyone deserves that well-rested sleep for a healthy start to their every day.

Vision & **Missions**

Vision

"To be among the leading brands in Asia's bedding industry by 2018".

Missions

"Continuously improvement on our product development capabilities, promote various solutions to ultimately expand and achieve great success for both domestic and international markets".



Winning Factors Of Goodnite

Business Policy

Focuses in providing bedding solutions that create for customers - their warmest and intimate moments.

Values

Customer Oriented

To prioritize customers' best intention by possessing initiative and commitment to achieve customers' satisfaction.

Genuine Interests

To understand, share and accept different view points for better results.

Teamwork

To work as a team by understanding, communicating, contributing ideas and trusting with utmost sincerity and care.

Improvement

To be optimistic, responsible, confident, enthusiastic to work and constantly improving oneself through continuous training.

Innovation

To continuously improve services and products through research and development efforts.

Effective and Efficient

To persistently seek for knowledge in order to achieve the best results.

Networking

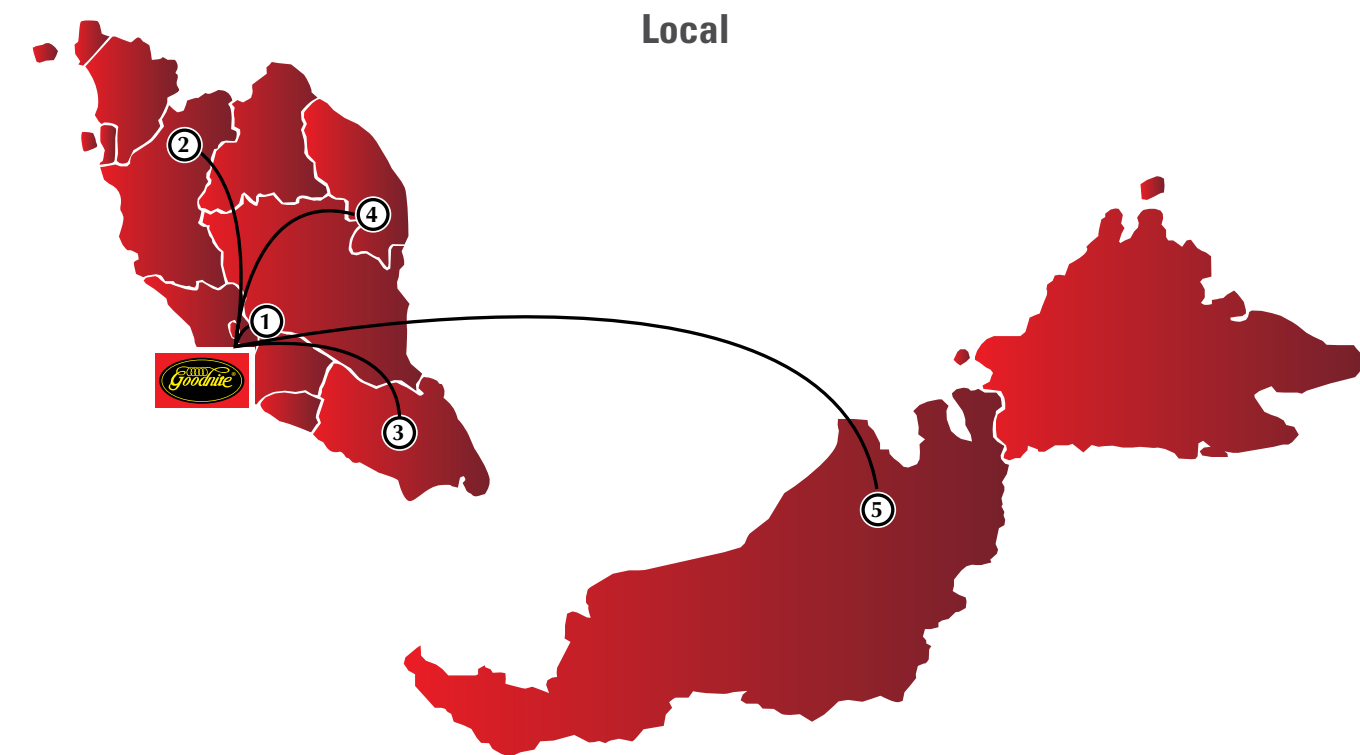

Goodnite approximately 1000 dealers in Malaysia.

1. Central Region
2. Northern Region
3. Southern Region
4. East Coast
5. East Malaysia (Sabah / Sarawak)

Networking

International

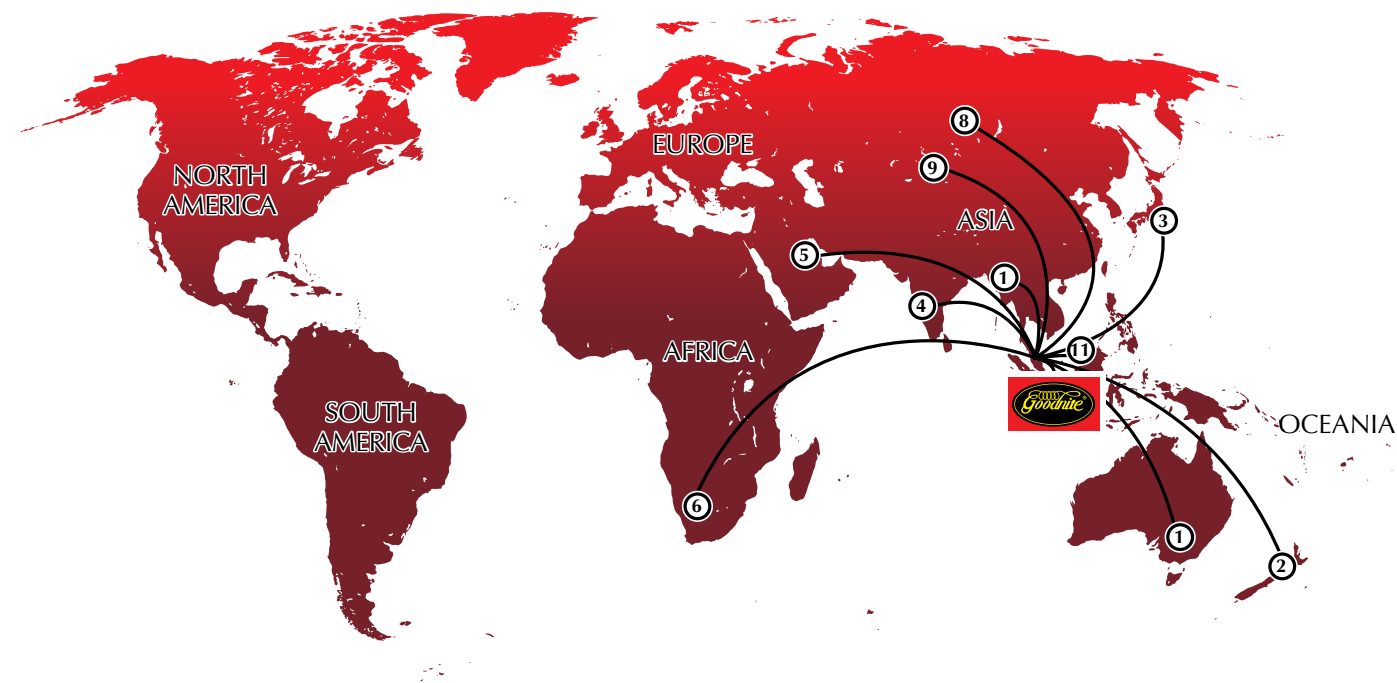

Goodnite is one of the largest mattress and bedding producers in Malaysia for both local and export markets. In the international arena, the mattress specialist is active in different regions in the world.

Established presence in countries such as:

- | | | | |
|----------------|-----------------|---------------|---------------|
| 1. Australia | 4. India | 7. Myanmar | 10. Singapore |
| 2. New Zealand | 5. UAE | 8. Russia | 11. Brunei |
| 3. Japan | 6. South Africa | 9. Kyrgyzstan | |

Expo & Exhibition

Goodnite has a history of successful marketing campaigns conducted through both above and below the line activities. The company has created brand awareness through newspaper and magazine advertisements in Malaysia and retails promotions.

Goodnite's campaigns are focused on the idea of "The art of healthy sleep". Goodnite participates in many exhibitions and organizes road shows to educate people on sleep needs and the effects of healthy sleep on their well being so that they can choose the right mattress for themselves and their families to achieve healthy sleep.

International Furniture Fair



Year 2011 - Export Furniture Exhibition Malaysia @ Malaysia Agro Exposition Park, Serdang, Selangor, Malaysia.

Expo & Exhibition

International Furniture Fair



Year 2010 - Export Furniture Exhibition Malaysia @ Malaysia Agro Exposition Park, Serdang, Selangor, Malaysia.



Year 2010 - Shenzhen International Furniture Exhibition, Shenzhen, China.

Expo & Exhibition

International Furniture Fair



Year 2009 - Export Furniture Exhibition Malaysia @ Malaysia Agro Exposition Park, Serdang, Selangor, Malaysia.



Year 2008 - Malaysia International Furniture Fair, Malaysia.

Expo & Exhibition

Malaysia Furniture Fair



Year 2011 - HomeDec Part 1 KLCC.



Year 2010 - Perfect Livin Part 1, PWTC.



Year 2010 - Perfect Livin Part 2, PWTC.

Expo & Exhibition

Malaysia Furniture Fair



Year 2010 - Malaysia Furniture & Furnishing Fair, KLCC.



Year 2010 - HomeDec Part 1 & Part 2, KLCC.



Year 2009 - Perfect Livin Part 1, PWTC.

Expo & Exhibition

Malaysia Furniture Fair



Year 2009 - HomeDec, KLCC.



Year 2008 - Perfect Living, KLCC.



Year 2008 - HomeDec, KLCC.

Successful Project

Some of the most renowned hotels and education institutions in the country such as Star Cruises, A Famosa Resort, Inti College and Universiti Malaysia also enjoy and welcome the expertise of Goodnite.



Brand Philosophy

Our Philosophy - Our focus in bedding solutions is crafted to create your every inch of comfort in the finest and warmest of moments.

Our vision looks forward to be among Asia's leading brands in the bed industry with mutual benefits for all eligible employees.

This leads into **our mission** to improve and promote the endless product development capabilities and solutions for an ultimate expansion and achievement on both the domestic and international markets.

Goodnite delivers not just bedding solutions but our pledges of commitment for your quality sleep:

Customer Oriented - Your best interests and satisfaction are prioritized with our constant initiative and enthusiasm.

Genuine Oriented - There are varying opinions and interests but by sharing and understanding them- we make them work together in synergy.

Teamwork - This is where our synergy comes in to fuel a sincere group environment of acceptance, communication, contribution and innovation to deliver our promise.

Improvement - With optimism, enthusiasm, confidence and responsibility, we keep and make a constant progress of ourselves to contribute even further.

Innovation - We don't stop at where we are because there's always more to do, more to advance, more to look forward to with various research and development efforts.

Effective and Efficient - It's persistence for the best results as we deliver your perfect sleep, tailored just for you.



Achievement

Goodnite believes in constant development to ultimately bring that one superiority of comfort for you. Along the way we've garnered a few milestones to illustrate that commitment and passion of Goodnite:

<p>2003</p> <p>Awarded as the first Malaysia mattress manufacturer for the prestigious "The 28th International Award for the Best Trade Name" in Rome, Italy</p> 	<p>2008</p> <p>Awarded "Product Excellence Award" by The Super Excellent Brand</p> 	<p>2011</p> <p>The National Mark of Malaysia Brand. The Mark of Quality, Excellence & Distinction</p>  
<p>2004</p> <p>Awarded "The Golden Europe Award for Quality and Commercial Prestige" in Paris, France.</p> 	<p>2008</p> <p>Awarded "Golden Bull Award" at the 6th Malaysia 100 Outstanding SMEs</p> 	
<p>2006</p> <p>Awarded "Superbrands, Malaysia" and received the accreditation of ISO 9001:2000 certification</p> 	<p>2010</p> <p>Awarded "SME Brand Excellent Award"</p> 	

Coil System Technology

Individual Pocketed Spring System

Everyone likes an undisturbed sleep. Goodnite's individual pocketed springs easily provides you that luxury as the spring system works independently from each other to ensure the movement of your companion doesn't affect you.

These springs, larger than ordinary springs and shaped like a wine barrel, are specifically designed to independently support the weight of your body in precise distribution without compromising your comfort while giving you a gentle yet flexible support.

Enjoy a serene sleep and take further comfort in knowing that your spine is well taken care of as you immerse yourself into the zone specific systems available; each one designed to fittingly support to your body contour's needs with softness and flexibility:-

- 7-Zone Individual Pocketed Spring System
- 5-Zone Individual Pocketed Spring System
- 3-Zone Individual Pocketed Spring System
- Individual Pocketed System



Double Posture Coil Spring System

You don't want to just sink in to your bed and wake up feeling aches all over. Goodnite's technology of the 6 turns-high carbon steelwire springs prevents that by providing improved stability and surface support. Designed to provide you greater stability, firmness and support, these springs are finely locked and knotted at both ends with small centre intricacy. Its key design provides an excellent diminishing weight deflection characteristic to accommodate both light and heavy loads. With interconnection of the springs by its helical formation, the load distribution also contributes to a lasting effect without having to worry of a quick wear out. A 4.0mm in diameter bordered rod attached to the other row of springs further enhances the mattress life by spreading the load from the edge adjacent springs, giving your mattress less chances for a break-down at the edge.

Relieving your pressure points with precise support, the system works together with high-density memory foam to allow constant ventilation for a pleasant and refreshing sleep.



Coconut Fibre

Using nature's finest; the specially manufactured mattress with natural coconut fibre relieves pressure, distributes even support for a superior spinal care, and encourages good blood circulation even as you sleep. This ideal natural mattress is moisture ventilation to keep you at a comfortable temperature throughout your nights.

- Well ventilation
- Water Penetration
- Superior Spinal Care
- Good Blood Circulation
- Natural Firmness
- Better Orthopedic Support
- Anti-Dust Mite
- Environment Friendly

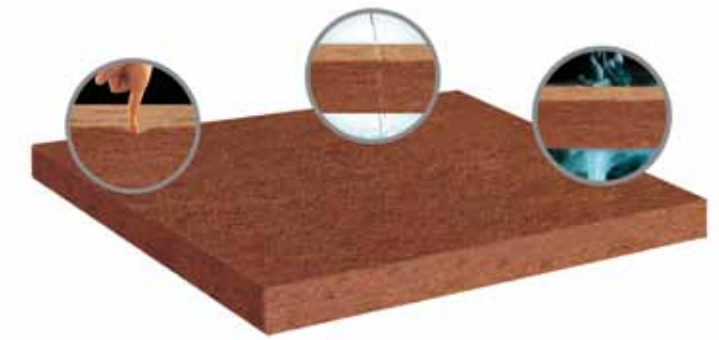

Natural Latex

Latex Mattresses are special manufactured to your body contours and cradle every curve of your body for superb comfort and back support, ensuring a perfect sleeping position. Latex is made of standard core which imported from Belgium with 5 firmness zone separated by bending edges. It is design with perforation on both sides, reinforced middle zone & softer shoulder and leg zone.

Latex Mattress are the perfect choice for allergy sufferers. Our quality euroLATEX have been proven to be anti-microbial and sanitized to inhibit the growth and spread of mildew, fungi and bacteria. So you can spend your night in the healthiest environment.

- 100% Natural Rubber
- Reversible
- Better Orthopaedic Support
- Environment Friendly
- Bacteria Free
- Non-Allergenic
- Anti-Dust Mite
- Soft-ventilating Structure
- Biodegradable



Memory Foam

Caring for you without compromising your sleep quality, the resilient memory foam works as a healthy best friend with its supportive quality for your body. Reinforce your comfort with its complete to cradle your body from top to bottom in a distributed manner.

Carefully moulding to your body contour with its temperature sensitive and open cell structure, it reacts effectively to each individual to create a custom adjustment to fit each body frame. This relieves pressure and takes off the sore spots you usually get from your lumpy mattress. Your blood circulation is improved and get an undisturbed sleep while you are at it.



Ticking Innovations

A SOFT SURFACE TEXTURE PROVIDES A TRANQUIL IMPRESSION AND GOODNITE ADDS A LITTLE EXTRA FOR THE PROTECTIVE FABRIC THAT ENCASES YOUR GOODNITE MATTRESS :

a. **Damask**

Curl yourself into your bed with an intricately crafted and imported quality ticking for that soft woven feeling.



b. **Linen**

As a highly absorbent and durable material with a superior cool surface, you get luxury softness and moisture-free feeling each time you get in and out of your bed.



c. **Fire Retardant**

The intelligent conception to resist ignition from cigarette-caused fire conditions.



d. **Bed Bug**

The protection offers you an ease of mind (and your nose!) from these microscopic bedding pests.



intense®

SLEEPING UNDER TENSION ?

The human body is one big electric field, continually recharging its electrons through contact and friction with other materials. Discharge comes into play when one element moves away from the other. The discharge is usually earthed straight away, but can also occur through ionisation discharge through the air. Just think of the crackling and sparks that appear when you slip off your sweater in the dark. This phenomenon is called 'corona'. The more electrons there are, the bigger the charge, and the human body can store up to 30,000 volts! Not surprisingly, these high voltages have a negative effect on our sleep. We feel nervous, agitated - we are literally experiencing a feeling of tension. So it is important for the body to get rid of this tension and drop to the lowest possible voltage. And that is exactly how Intense works.

- Electrostatic field caused by friction between materials
- A body can reach 30,000 volts
- Negative impact on sleep patterns
- More nervous, restless, and literally more tense
- The voltage needs to be discharged

PROVEN SCIENTIFICALLY

One of the world's leading specialists in sleep research, Professor Chris Idzikowsky, took a very close look at how Intense works. He put 26 people through a series of tests, both subjective and objective. The results were remarkable. On an active mattress, the sleep becomes more efficient by 4.3% from the second night on. For a normal night's sleep, the subjects needed 21 minutes less on average or put another way, one night per month! What's more, those who tried the test considered Intense to be particularly comfortable. Intense can easily be used in woven or knitted ticking. It actively repels dust (good news for asthmatics), is perfectly washable and has a long, active life. The filament structure can be neither seen nor felt. The benefits of Intense are spectacular: you sleep better and gain more than 20 minutes per day!

- Tested by Prof.Dr.Idzikowski
- Sample of 26 people
- Over 8 hours needed 21 minutes less sleep
- Dust repellent (good news for people with asthma)
- Completely washable

BYE BYE TENSION

In the course of the night, the body is in constant contact with various materials, such as pajamas, sheets, mattress etc. Both the body and these materials are continually recharged with static electricity - up to 30,000 volts! If we want a truly peaceful sleep, it is clear that this tension needs to be discharged and the voltage lowered - without earthing. Intense offers a solution to this problem. The intense mattress uses ultra-fine, multifilament carbon fibre thread. Each filament contains a conductive trilobal core, wrapped in a protective nylon envelope. The carbon filament captures the electrons in the surrounding material and releases them into the air at low voltage (from 4,000 volts). So the tension literally flows away from the body, allowing for deeper - and more relaxing - sleep.

- Accelerated discharge
- Intense is the solution
- Mattress ticking with carbon thread
- Conductive core absorbs electrons
- The voltage difference disappears





model

North Star

3567 units Individual Pocketed Spring Mattress with Natural Latex & High Density Memory Foam

Quilted with luxuriously plush top & pillow top designed and quality designed tape edging finishing. With latest Intense ticking to discharge the body static for an tranquil rest, imported from Europe. Corroborated with a world famous crystal company to accessories the mattress border, transforming an often neglected part of the bed into a point of focus point.

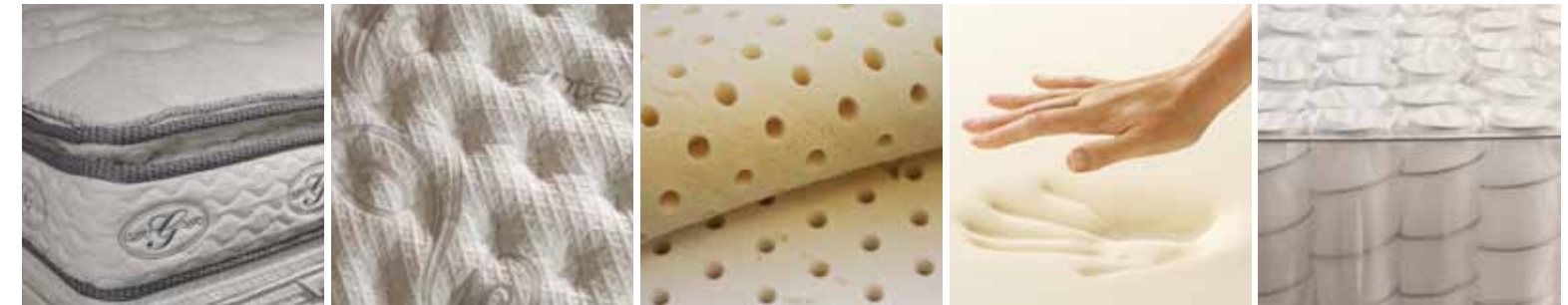

Pillow Top With Plush Top

intense® Ticking

Natural Latex

Memory Foam

Individual Pocketed Spring



Headboard & Divan : CC BD 1005

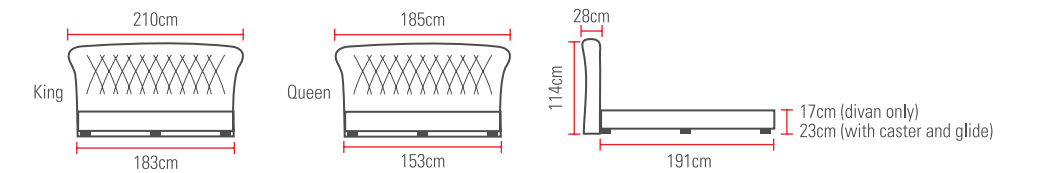

- warranty
- anti-dust mite
- anti-bacteria
- anti-fungus
- superior hanging action
- reduce partner disturbance
- static free
- turn free



model **EL-300**

5-Zone Pocketed Spring Mattress with 4" Pillow Top with Latex & Plush Top with **intense® Anti-Static Fabric**

For unsurpassed comfort, the 5-zone individual pocketed spring mattress cradles your body specifically from head to toe. Harmonized with a latex pillow top to relieve your pressure points, the spring system also minimize your sleeping partner's motion while enhancing the mattress lifespan. The mattress is also enhanced with anti-dust mite property and intense® ticking to reduce your body static for a rejuvenating sleep.



Pillow Top With Plush Top

intense® Ticking

Luxury Handle Design

Natural Latex

5-Zone Individual Pocketed Spring System

Headboard & Divan : CC BD 1005

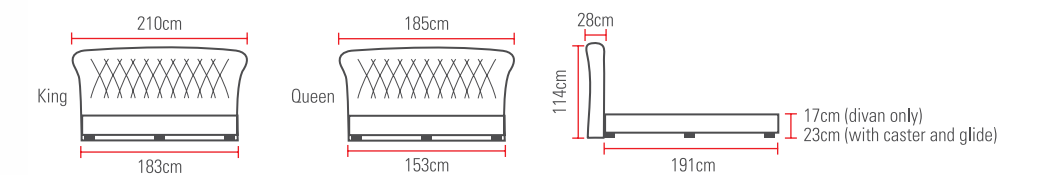

- warranty
- anti-dust mite
- anti-bacteria
- anti-fungus
- superior hanging action
- reduce partner disturbance
- static free



model **EL-200**

3-Zone Pocketed Spring Mattress with 2" Memory Foam Pillow Top with **intense® Anti-Static Fabric**

With a 3-zone individual pocketed spring system, the curves of your body are supported to the maximum as your back obtains an excellent precise support. Disturbance throughout the night is reduced with the memory foam pillow top, while intense® ticking boosts your sleep quality by reducing the day's tension from your body.



Pillow Top

intense® Ticking

Luxury Handle Design

Memory Foam

3-Zone Individual Pocketed Spring System

Headboard & Divan : Da Vinci

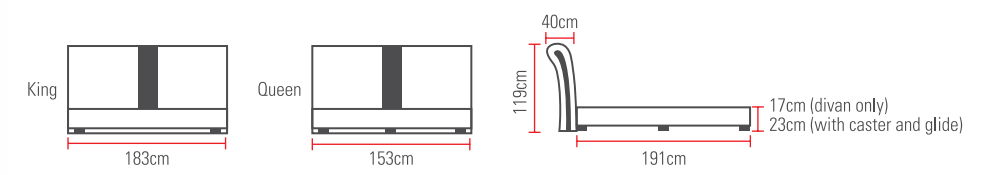

- warranty
- anti-dust mite
- anti-bacteria
- anti-fungus
- superior hanging action
- reduce partner disturbance
- static free



model **EL-100**

Double Posture Coil Spring Mattress with Double Plush Top & **intense® Anti-Static Fabric**

The double posture coil spring system provides an improved weight distribution for uncompromised support and enduring durability. Excellent spinal care with natural relief of pressure points as you sleep, you'll feel refresh each time as we top it off with intense® ticking to discharge your body static for an tranquil rest.



Pillow Top With Double Plush Top

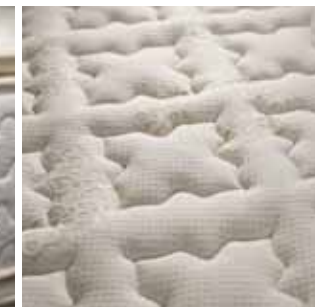

intense® Ticking



Luxury Handle Design



Double Posture Coil™ Spring

Headboard & Divan : Health Plus

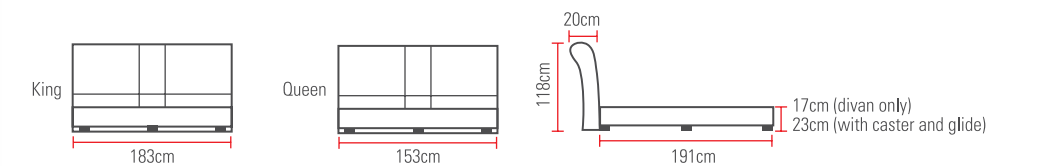

warranty



anti-dust mite



anti-bacteria



anti-fungus



superior hanging action



static free



model **ROYAL STAR**

The prestige comfort of imported linen ticking and individual pocketed spring to give you a superior spinal care alongside reduced partner disturbance.

- Reduces Partner Disturbance
- Superior Spinal Care



Linen Ticking



Individual Pocketed Spring



Headboard & Divan : Tokio

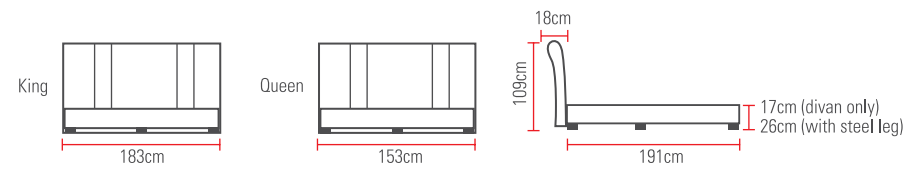

- 12 years** warranty
- anti-dust mite
- anti-bacteria
- anti-fungus
- superior hanging action
- reduce partner disturbance



model **i-Matt**

Individual Pocketed Spring with Latex Layer Mattress eases your body into a restful and deep sleep.

- Reduces Partner Disturbance
- Superior Spinal Care
- Imported Linen Ticking



Linen Ticking

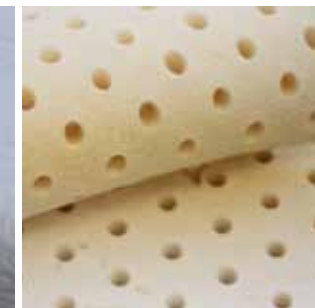

100% Natural Latex



Individual Pocketed Spring



Embroidery Label

Headboard & Divan : GN 100

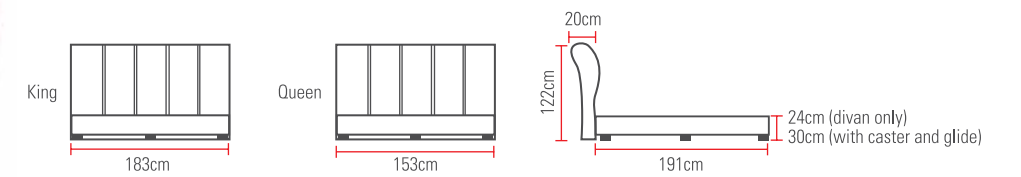

12 years warranty



anti-dust mite



anti-bacteria

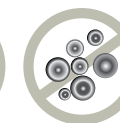

anti-fungus

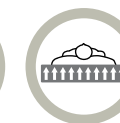

superior hanging action

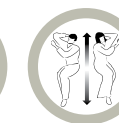

reduce partner disturbance



model **Chirostar®**

Presented with intricately designed Linen Ticking and a harmonized combination of plush top layer with foam with posture spring coil for superior firmness and last comfort.

- Superior back support with plush top layer
- With luxury softness imported Linen ticking and anti-dust mite protection
- Mattress thickness : 13"(H)

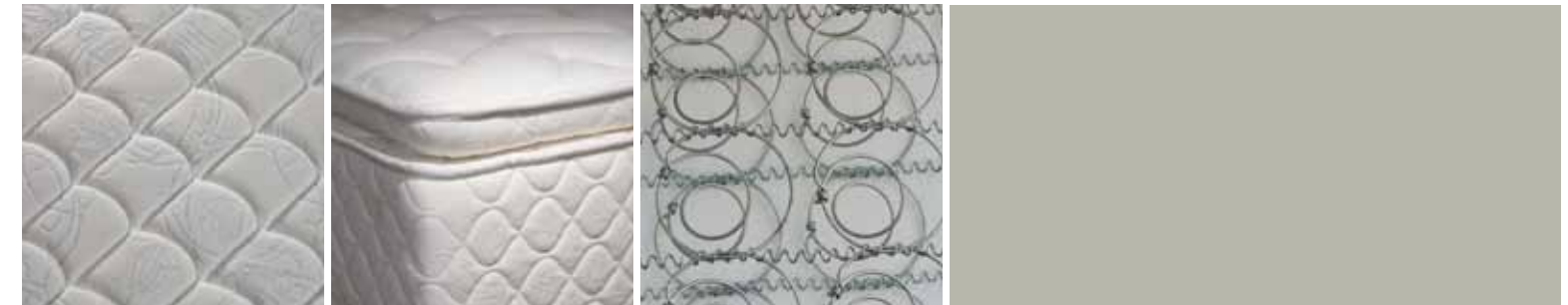

Linen Ticking

Pillow Top

Posture Spring System



Headboard & Divan : BD 1008

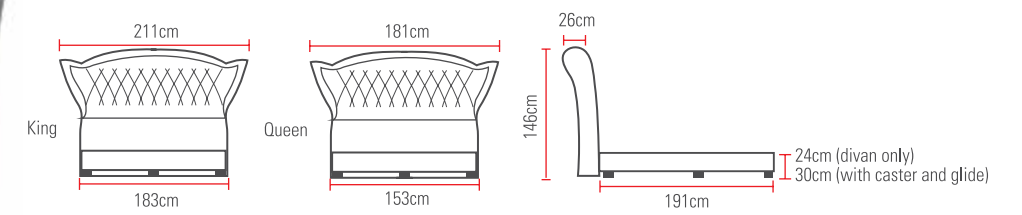



model **FIBRE 100**

100% coconut fibre to effectively improve blood circulation and promising superior spinal care. Its ventilation and water penetration wick moisture away to provide you a fresh and dry environment throughout your sleep.

- Well Ventilation
- Water Penetration
- Superior Spinal Care
- Good Blood Circulation
- Natural Firmness



Damask Ticking



100% Coconut Fibre



Headboard & Divan : PU 300

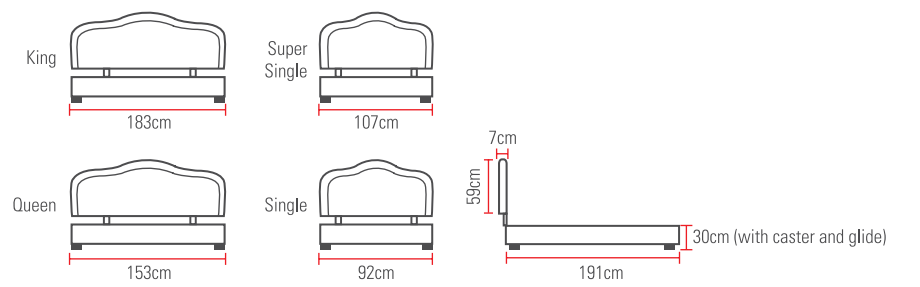



model | **PURETEX**

The 100% natural latex with its anti-microbial property presents itself as an environmental friendly choice while promoting a precise 5-zone support to cradle and cushion your body contours. Reversible and biodegradable with removable cover, its properties of a self-ventilating system and non-allergenic properties also makes it an excellent choice for both you and the environment.

- Standard Core with 5 Firmness Zone separated bending edges
- Reversible
- Anti-Dust Mite
- Bacteria Free
- Removable Cover
- Non-allergenic
- Environmental Friendly
- Biodegradable
- Better orthopedic Support
- Self-ventilating structure



Linen Ticking



100% Natural Latex

Headboard & Divan : CC BD 1001

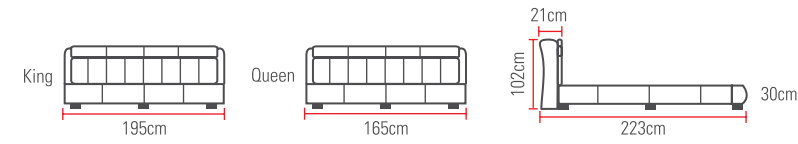

10 years
warranty

anti-dust mite

anti-bacteria

anti-fungus



model | **Hotel I**

- Standard Bonnel Spring Mattress
- Imported Damask Ticking
- Anti Dust Mite
- 10 Years Warranty
- Mattress Thickness : 8.25"



Imported Damask Ticking



Pillow Top



Luxury Handle Design

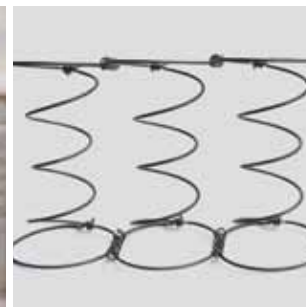

Bonnel Coil



Headboard & Divan : PU Headboard

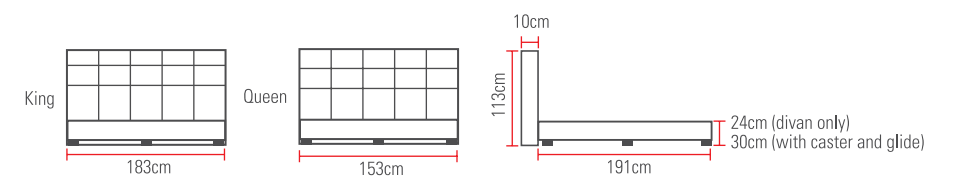



model

Hotel II

Standard Bonnel Spring Mattress with Plush Top Layer

- Imported Damask Ticking
- Anti Dust Mite
- 10 Years Warranty
- Mattress Thickness: 9"



Imported Damask Ticking



Pillow Top With Plush Top



Luxury Handle Design

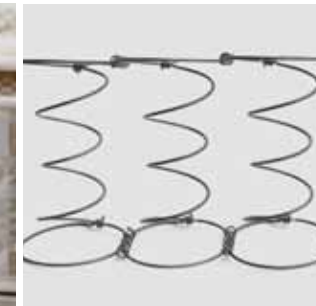

Bonnel Coil

Headboard & Divan : PU Headboard

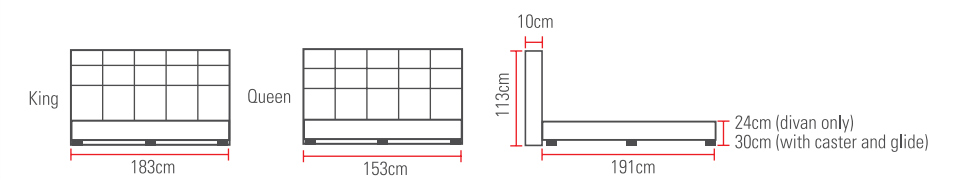



model | **Hotel III**

- Double Posture Coil Spring Mattress
- Fire Retardant Ticking
- Anti Dust Mite
- 12 Years Warranty
- Mattress Thickness: 9"

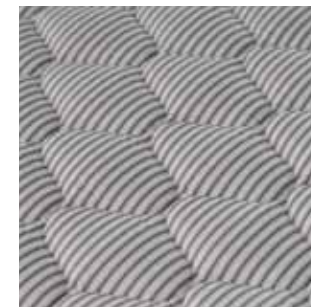

Imported Damask Ticking

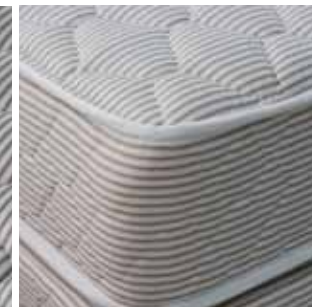

Pillow Top With Plush Top



Air Hole



DPC Coil

Headboard & Divan : GN 100

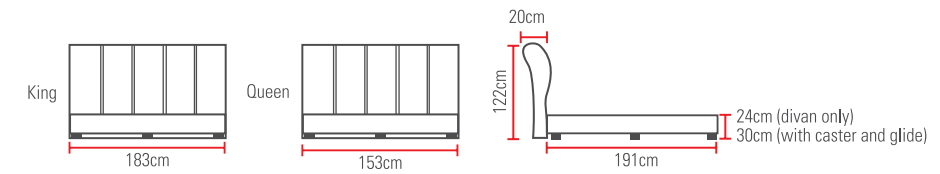

warranty



anti-dust mite



model **Hotel IV**

Individual Pocketed Spring Mattress with Plush Top Layer

- Fire Retardant Ticking
- Anti Dust Mite
- 12 Years Warranty
- Mattress Thickness: 11"



Fire Retardant Ticking



Pillow Top With Plush Top



Luxury Handle Design



Individual Pocketed Spring



Headboard & Divan : GN 100

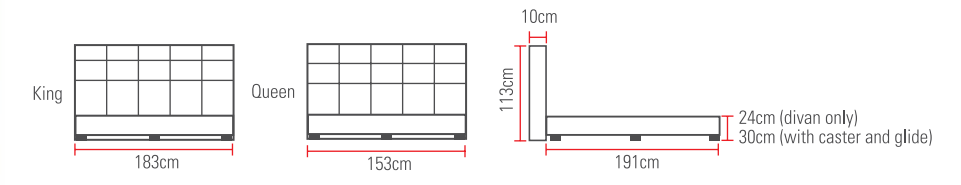



model **SPINA STAR**

High Quality Reborn with Plush Top mattress

- The only extra layer of poly fibre incorporated for extra comfort and spinal support
- Imported Linen ticking for more superior soft
- Unique craftsmanship's designed to suit body contour



Linen Ticking

Plush Top Layer

High Quality Rebonded Foam

Headboard & Divan : Tokio

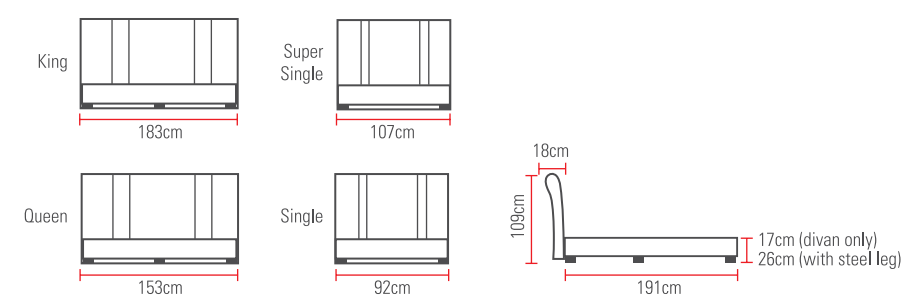



model **LITTLE ANGEL**

Using the conventional bonnel spring system and imported mosquito-free ticking with a two in one bed, it's a concept to save space while enjoying the basics comfort for a good sleep.

- Complete set includes PU Headboard, Divan, 3' Mattress, 3' 6" Super Single Mattress & Pull Out Metal Rack
- Superior Firmness & Comfort
- Import Mosquito Free Ticking



Mosquito Free Ticking

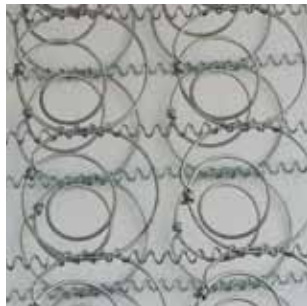

Standard Bonnel Spring System

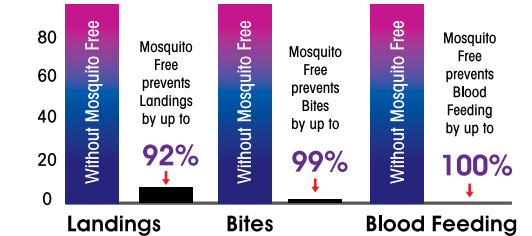

10 years warranty



anti-dust mite



anti-bacteria



anti-fungus



Function 1

Lift-up the pull-out rack & mattress to same level as the topper mattress to become a King Bed



Function 2

Pull-out your mattress become double decker bed (either pull-out to left or right)



Function 3

Storage your mattress underneath the box divan



model **ZEN BED**

Standard Bonnel Spring Divan

- Superior softness
- Imported Cotton Ticking
- Available in orange and green color
- Available in super single (3' 6") size only



Cotton Ticking

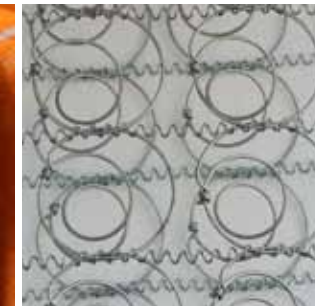

Standard Bonnel Spring System

Super Single Only



Front View



Side View

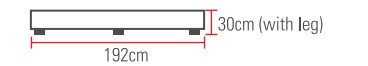

warranty



anti-dust mite



anti-bacteria



anti-fungus

Bedding Accessories

Memory Topper

Offering a layer of superior comfort to your matters, the Memory Topper also warmly molds to your body by reacting to your weight for a precise balance to relief your pressure points. The memory foam also works as a natural antibacterial surface to ease your allergy worries.

- Made of high-density, solid visco-elastic memory foam
- Mattress topper cradles your body and reduces pressure points to prevent tossing and turning conform to your body's curves to give you better sleep
- Memory foam is resistant to dust mites and is naturally antimicrobial
- Roll able, non foldable
- 5 Years warranty



Mattress Topper



Memory Foam



Bedding Accessories

Pure Latex Topper

Experience its firmness zone to support your body like a perfect fit, providing you excellent orthopedic support in a bacteria-free, anti-dust mite environment. Its self-ventilating structure and non-allergenic property keeps you in a comfortable and even temperature throughout you sleep.

- 100% Natural Latex Mattress Topper with 5-Zone Support
- Removable Cover
- Reversible
- Non-allergenic
- Better orthopedic support
- Anti-Dust mite



Mattress Topper



100% Natural Latex

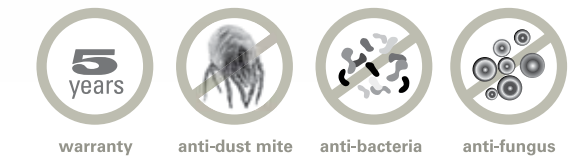

Bedding Accessories



Memofoam Pillow

The memory pillow is made of high density contoured memory foam which supports your head, neck and shoulders to allow your muscles to relax as well as help neck and spine properly aligned for a restful sleep.

The Memofoam Pillow utilizes an incredible new fabric made of carbon fiber elements. A conductive trilobal core, wrapped in a protective nylon envelope captures electrons and releases them into the air at a low voltage. Tension literally flows from the body, allowing a deeper, more relaxed sleep.

- Outstanding elasticity
- Excellent neck support
- Long-lasting
- Self-ventilating and moisture regulating
- Sanitized against bacteria & fungus
- Static tension free
- 5 years warranty

Intentic Pillow

- 100% Natural Latex offer gentle resilience so your head and shoulders are comfortably supported in all sleeping positions.
- Hundreds of tiny cores have been created within the pillow allowing air ventilating for a fresh and refreshing night's sleep.
- The knobs created for facilitate blood circulation.
- The knobs also provide softness and mild massage feeling.
- intense® ticking improves sleep by lowering the body's static charge.
- Excellent neck support
- Long-lasting
- 5 years warranty



Bedding Accessories



Polyester Pillow & Bolster

- Made of high quality polyester fibre, with polyester cotton cover, which is soft and has good insulation properties.
- They are easy to clean and can be machine-wash.



Synthetic Pillow & Bolster

- Better neck support
- Superior quality
- Extra resilient



Bedding Accessories

Mattress Protector

Mattress Protector is covered with polyester cotton, which gives you further protection, freshness and comfort. It is lightweight and can retain softness and shape. Mattress protector has 4 corner elastic straps for easy fitting and easy maintenance.



Anti-Dust Mite Mattress Protector

ADM Mattress Protector is covered with 100% Anti Dust Mite cotton fabric, which can prevent effectively the pollution of bedding collections result from fungus, so it can bring you the real healthy sleep. The product has the function of anti-dust mite, it can clear away the mites in the bedding collection completely by the methods of cutting of food chain of the mites. So you will not worry about the diseases such as asthma and allergic dermatitis any more.



Mattress Care Guide

DO:

- Upon removal of the packaging materials, allow your new mattress time to "breathe". 12 hours is recommended.
- Handle or carry your mattress correctly to prevent damage.
- Keep your mattress clean constantly. Change the bed spreads on a regular basis or use a mattress protector (pad).
- Check the divan for wear and tear regularly which may contribute to insufficient support and cause the mattress to sag.
- Turn our mattress every 4 months to prolong lifespan and evenly distribute body impressions (indentations). These body impressions are normal and occur when the upholstery layers conform to your individual contours to provide comfort and support.

DON'T:

- Do not smoke in bed.
- Do not jump or stand on mattress. Mattresses were not designed or built for that type of load distribution. If it were, then the mattress would be hard as a rock!
- Do not allow your mattress to get wet as it will compress upholstery materials and affect the comfort level and your satisfaction.
- Do not bend the mattress more than 25 degrees as it will damage the coil system.

10 Tips for Better Sleep

We all have too much to do, so don't forget to take time out and recharge yourself through a good night's sleep. The quality and quantity of your sleep can make all the difference in how productive you'll be the next day. Here are 10 tips to help you get the sleep you need and deserve.

1. Maintain a regular bed and wake time schedule, including weekends.
2. Establish a regular, relaxing bedtime routine such as soaking in a hot bath or hot tub and then reading a book or listening to soothing music.
3. Create a sleep-conductive environment that is dark, quiet, comfortable and cool.
4. Sleep on a comfortable mattress and pillows.
5. Use your bedroom only for sleep and sex. It is best to take work materials, computers and televisions out of the sleeping environment.
6. Finish eating at least two to three hours before your regular bedtime.
7. Exercise regularly. It is best to complete your workout at least a few hours before bedtime.
8. Avoid nicotine (e.g. cigarettes, tobacco products). Used close to bedtime, it can lead to poor sleep.
9. Avoid caffeine (e.g. coffee, tea, soft drinks, chocolate) close to bedtime. It can keep you awake.
10. Avoid alcohol close to bedtime. It can lead to disrupted sleep later in the night.

Mattress **Buying Guide**

You need to understand your sleep needs before start shopping for your mattress!

1. **COMFORT.** Gone are the days when a mattress had to be stiff-as-a-board to be good for you. And it's interesting to note that recent studies suggest that a medium-firm mattress is more likely to improve back pain than a firm mattress.

You'll sleep best when your bed helps you feel cradled in comfort. Today's top quality mattress / foundation ensembles are built for just that - superior comfort. Luxurious new cushioning materials and extra-soft surface treatments create more of a plush, comfortable feel. Additionally, it is normal for some body impressions to appear in the first few weeks of sleeping on such mattresses.

2. **SUPPORT.** Correct support is the essential ingredient for a healthy body. A good mattress and foundation will gently support your body at all points and keep your spine in the same shape as a person with good standing posture. Pay special attention to your shoulders, hips, and lower back - the heaviest parts. If there's too little support, you can develop back pain. But if the mattress is too hard for you, you can experience uncomfortable pressure.

3. **DURABILITY.** It's the quality of the materials used and how they're put together that determine how long a mattress and foundation will provide the comfort and support you bought them for. The best assurance of good performance over a good many years is to buy the highest quality sleep set you can afford.

4. **SPACE.** Cramped quarters can turn sleeping into a nightly wrestling match. A healthy sleeper moves anywhere from 40-60 times a night, including some dozen full body turns. You need freedom of motion while you sleep and to help you relax while you're falling asleep. If you sleep with a partner, be sure to select a queen or king size bed. Both are not only wider, but several inches longer than the standard "double"(full size), which offers each sleeper only as much space as a baby in a crib.

Take the **SLEEP** Test

Before purchasing a mattress, it's important that you and your partner take the SLEEP test to help ensure that you are selecting a mattress that's right for your comfort and space needs. Here's how you take the SLEEP Test:

- **S**elect a mattress.
- **L**ie down in your sleep position.
- **E**valuate the level of comfort and support.
- **E**ducate yourself about each selection.
- **P**artners should shop together.

Don't be embarrassed! You don't think twice about test driving a car, so you shouldn't think twice about "sleep testing" a mattress. Lie down on the mattress for several minutes and assess how well it provides support and how comfortable it is for you and your partner. The only way to tell if a mattress is right for you is to lie down on it!

Goodnite Sdn. Bhd. (447372-U)

Customer Care Line +603-3250 2218

Wisma Goodnite, Lot 1249, Jalan Kapar, Batu 15,
42200 Klang, Selangor Darul Ehsan, Malaysia.
Tel : +603-3250 3333 Fax : +603-3250 7888
Email : info@goodnite.com.my



www.facebook.com/MyGoodnite

A Fresh Morning After A **Good Night**

